

# WCB-Flow Products

An SPX Process Equipment Operation

[www.spxprocessequipment.com](http://www.spxprocessequipment.com)

## Fittings for the Pharmaceutical and Biotech Industries

WCB-Flow Products offers the widest range of fittings and surface finishes available for use in the Pharmaceutical and Biotech industries. Fittings are offered in a wide range of sizes from 1/2" through 6" in both butt weld and S-Line clamp connections according to ASME BPE standards. Interior surface finishes are available from 20 Ra Max mechanical polish to 10 Ra Max Electropolished per ASME BPE specifications. Additionally, BPE dimensionally compliant fittings also are offered in an unpolished surface finish.

### Material and Traceability

WCB-Flow Products offers fittings to BPE dimensions in 316L, and other specialty alloys. All fittings are permanently marked with original heat numbers allowing full traceability back to the original stainless steel supplier. MTR information is available for download from our website at [www.spxprocessequipment.com](http://www.spxprocessequipment.com). All tubular materials meet ASTM A269 / A270 requirements and all machined components meet the requirements of ASTM A479.

### Heat Treatment

All fittings manufactured by WCB-Flow Products are solution annealed and treated in a vacuum furnace. This treatment relieves stresses caused by cold forming operations used in the manufacturing process, thereby removing the potential for stress corrosion and improving the dimensional stability of fittings.

### Polish Options

WCB-Flow Products offers multiple polish options to suit the needs of the industry. They range from unpolished to 10 Ra Max fittings, and include interior polish (#3) and interior/exterior polish (#7) options.

Polish offerings are outlined in the table below:

Surface Finish Code	Maximum Interior Surface Finish	Exterior Surface Finish	ASME BPE Surface Finish Designation
#3 (PC)	20 Ra Mechanical	Unpolished	SFF1
#7 (PL)	20 Ra Mechanical	Polished	SFF1
#3E (PD)	15 Ra Electropolish	Unpolished	SFF4
#7E (PM)	15 Ra Electropolish	Polished	SFF4
#3E (PJ)	10 Ra Electropolish	Unpolished	
#7E (PR)	10 Ra Electropolish	Polished	
#0 (PU)	Unpolished	Unpolished	



## Inspection Procedures

All fittings produced by WCB-Flow Products are 100% visually inspected for any surface finish imperfections as mentioned in the ASME BPE specification. Additionally, internal acceptance criteria for the Off Angle characteristic is more than 60% tighter than ASME published tolerances for improved fit and weldability of product. As a part of rigorous inspection standard, heat number traceability is verified for accuracy and chemical composition before the fittings are packaged for shipment.

- Roundness

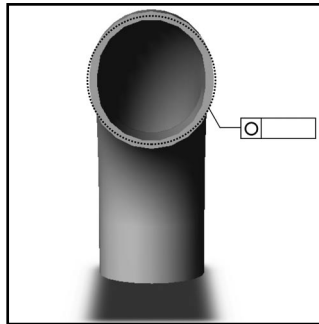

- Wall Thickness

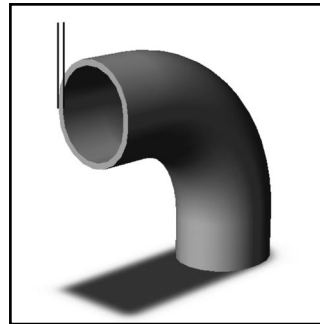

- Squareness Face to tangent

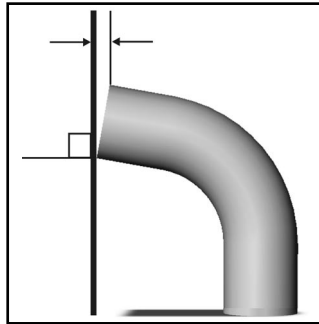

- Off Angle

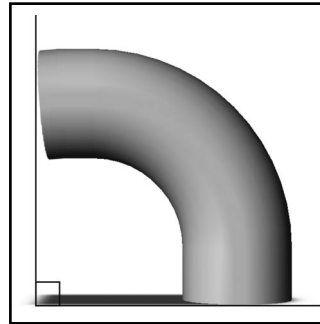

- Off Plane

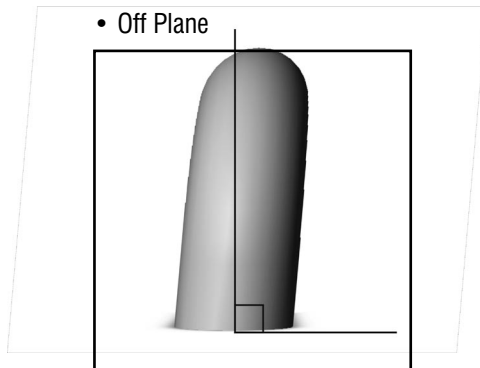

- Height

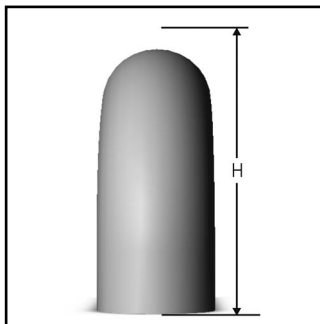

## Fittings Marking

Each fitting is marked with the following:

- “WCB-FP”
- Heat number on each on component
- Material Alloy
- ASME BPE
- Surface Designation per ASME BPE

## Packaging

- The ends, either clamp or weld, are capped to prevent damage and contamination
- All fittings are packaged in resealable bags.
- All bags are labeled with WCB-Flow Products Part Number, Heat Number(s), ASME BPE, and the appropriate ASME BPE Surface Finish Designation for traceability and tracking purposes.
- WCB-Flow Products color codes the end caps for easy distinction of different interior surface finishes. Refer to the color code below:

Surface Finish	Cap Color	ASME BPE Surface Finish
Mechanical Polish	Red	SFF1
Electropolished	Blue	SFF4



**90 DEGREE ELBOW T316L BPE**

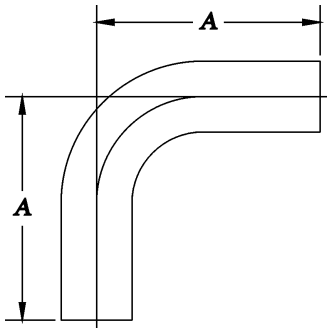

**S2S**

SIZE (in)	20 Ra (SFF1)		15 Ra-EP (SFF4)		10 Ra MAX-EP		Unpolished #0 (PU)	A in
	#3 (PC)	#7 (PL)	#3E (PD)	#7E (PM)	#3E (PJ)	#7E (PR)		
1/2	02090AE061	02090BE061	02090AE071	02090BE071	02090GE071	02090HE071	020900E061	3
3/4	02090AF061	02090BF061	02090AF071	02090BF071	02090GF071	02090HF071	020900F061	3
1	02090A1061	02090B1061	02090A1071	02090B1071	02090G1071	02090H1071	0209001061	3
1-1/2	02090A2061	02090B2061	02090A2071	02090B2071	02090G2071	02090H2071	0209002061	3-3/4
2	02090A3061	02090B3061	02090A3071	02090B3071	02090G3071	02090H3071	0209003061	4-3/4
2-1/2	02090A4061	02090B4061	02090A4071	02090B4071	02090G4071	02090H4071	0209004061	5-1/2
3	02090A5061	02090B5061	02090A5071	02090B5071	02090G5071	02090H5071	0209005061	6-1/4
4	02090A6061	02090B6061	02090A6071	02090B6071	02090G6071	02090H6071	0209006061	8
6	02090A7061	02090B7061	02090A7071	02090B7071	02090G7071	02090H7071	0209007061	11-1/2

**90 DEGREE ELBOW / FERRULE T316L BPE**

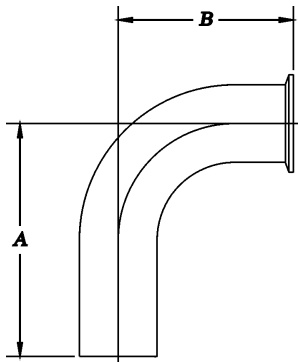

**S2CKW**

SIZE (in)	20 Ra (SFF1)		15 Ra-EP (SFF4)		10 Ra MAX-EP		Unpolished #0 (PU)	A in	B in
	#3 (PC)	#7 (PL)	#3E (PD)	#7E (PM)	#3E (PJ)	#7E (PR)			
1/2	02019AE061	02019BE061	02019AE071	02019BE071	02019GE071	02019HE071	020190E061	3	1-5/8
3/4	02019AF061	02019BF061	02019AF071	02019BF071	02019GF071	02019HF071	020190F061	3	1-5/8
1	02019A1061	02019B1061	02019A1071	02019B1071	02019G1071	02019H1071	0201901061	3	2
1-1/2	02019A2061	02019B2061	02019A2071	02019B2071	02019G2071	02019H2071	0201902061	3-3/4	2-3/4
2	02019A3061	02019B3061	02019A3071	02019B3071	02019G3071	02019H3071	0201903061	4-3/4	3-1/2
2-1/2	02019A4061	02019B4061	02019A4071	02019B4071	02019G4071	02019H4071	0201904061	5-1/2	4-1/4
3	02019A5061	02019B5061	02019A5071	02019B5071	02019G5071	02019H5071	0201905061	6-1/4	5
4	02019A6061	02019B6061	02019A6071	02019B6071	02019G6071	02019H6071	0201906061	8	6-5/8
6	02019A7061	02019B7061	02019A7071	02019B7071	02019G7071	02019H7071	0201907061	11-1/2	10-1/2

## 45 DEGREE ELBOW T316L BPE

SIZE (in)	20 Ra (SFF1)		15 Ra-EP (SFF4)		10 Ra MAX-EP		Unpolished #0 (PU)	A in
	#3 (PC)	#7 (PL)	#3E (PD)	#7E (PM)	#3E (PJ)	#7E (PR)		
1/2	02590AE061	02590BE061	02590AE071	02590BE071	02590GE071	02590HE071	025900E061	2-1/4
3/4	02590AF061	02590BF061	02590AF071	02590BF071	02590GF071	02590HF071	025900F061	2-1/4
1	02590A1061	02590B1061	02590A1071	02590B1071	02590G1071	02590H1071	0259001061	2-1/4
1-1/2	02590A2061	02590B2061	02590A2071	02590B2071	02590G2071	02590H2071	0259002061	2-1/2
2	02590A3061	02590B3061	02590A3071	02590B3071	02590G3071	02590H3071	0259003061	3
2-1/2	02590A4061	02590B4061	02590A4071	02590B4071	02590G4071	02590H4071	0259004061	3-3/8
3	02590A5061	02590B5061	02590A5071	02590B5071	02590G5071	02590H5071	0259005061	3-5/8
4	02590A6061	02590B6061	02590A6071	02590B6071	02590G6071	02590H6071	0259006061	4-1/2
6	02590A7061	02590B7061	02590A7071	02590B7071	02590G7071	02590H7071	0259007061	6-1/4

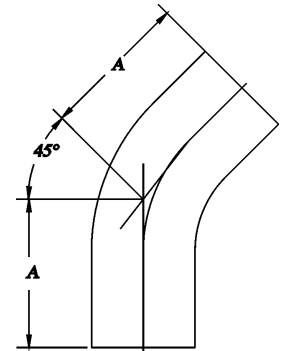

S2KS

## 45 DEGREE ELBOW / FERRULE T316L BPE

SIZE (in)	20 Ra (SFF1)		15 Ra-EP (SFF4)		10 Ra MAX-EP		Unpolished #0 (PU)	A in	B in
	#3 (PC)	#7 (PL)	#3E (PD)	#7E (PM)	#3E (PJ)	#7E (PR)			
1/2	02519AE061	02519BE061	02519AE071	02519BE071	02519GE071	02519HE071	025190E061	2-1/4	1
3/4	02519AF061	02519BF061	02519AF071	02519BF071	02519GF071	02519HF071	025190F061	2-1/4	1
1	02519A1061	02519B1061	02519A1071	02519B1071	02519G1071	02519H1071	0251901061	2-1/4	1-1/8
1-1/2	02519A2061	02519B2061	02519A2071	02519B2071	02519G2071	02519H2071	0251902061	2-1/2	1-7/16
2	02519A3061	02519B3061	02519A3071	02519B3071	02519G3071	02519H3071	0251903061	3	1-3/4
2-1/2	02519A4061	02519B4061	02519A4071	02519B4071	02519G4071	02519H4071	0251904061	3-3/8	2-1/16
3	02519A5061	02519B5061	02519A5071	02519B5071	02519G5071	02519H5071	0251905061	3-5/8	2-3/8
4	02519A6061	02519B6061	02519A6071	02519B6071	02519G6071	02519H6071	0251906061	4-1/2	3-1/8
6	02519A7061	02519B7061	02519A7071	02519B7071	02519G7071	02519H7071	0251907061	6-1/4	5-1/4

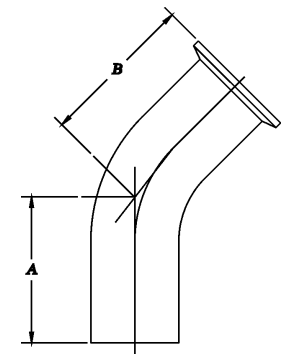

S2KKW

**TEE T316L BPE**

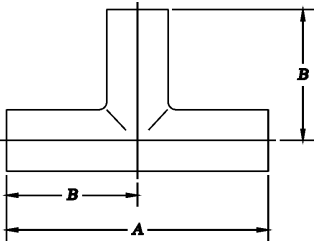

**S7WWW**

SIZE (in)	20 Ra (SFF1)		15 Ra-EP (SFF4)		10 Ra MAX-EP		Unpolished #0 (PU)	A in	B in
	#3 (PC)	#7 (PL)	#3E (PD)	#7E (PM)	#3E (PJ)	#7E (PR)			
1/2	07090AE061	07090BE061	07090AE071	07090BE071	07090GE071	07090HE071	070900E061	3-3/4	1-7/8
3/4	07090AF061	07090BF061	07090AF071	07090BF071	07090GF071	07090HF071	070900F061	4	2
1	07090A1061	07090B1061	07090A1071	07090B1071	07090G1071	07090H1071	0709001061	4-1/4	2-1/8
1-1/2	07090A2061	07090B2061	07090A2071	07090B2071	07090G2071	07090H2071	0709002061	4-3/4	2-3/8
2	07090A3061	07090B3061	07090A3071	07090B3071	07090G3071	07090H3071	0709003061	5-3/4	2-7/8
2-1/2	07090A4061	07090B4061	07090A4071	07090B4071	07090G4071	07090H4071	0709004061	6-1/4	3-1/8
3	07090A5061	07090B5061	07090A5071	07090B5071	07090G5071	07090H5071	0709005061	6-3/4	3-3/8
4	07090A6061	07090B6061	07090A6071	07090B6071	07090G6071	07090H6071	0709006061	8-1/4	4-1/8
6	07090A7061	07090B7061	07090A7071	07090B7071	07090G7071	07090H7071	0709007061	11-1/4	5-5/8

**TEE / BRANCH FERRULE T316L BPE**

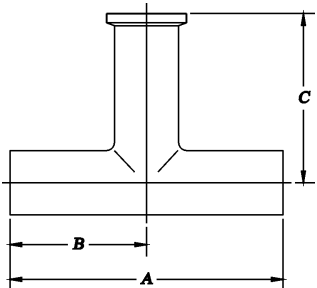

**S7WWK**

SIZE (in)	20 Ra (SFF1)		15 Ra-EP (SFF4)		10 Ra MAX-EP		Unpolished #0 (PU)	A in	B in	C in
	#3 (PC)	#7 (PL)	#3E (PD)	#7E (PM)	#3E (PJ)	#7E (PR)				
1/2	07091AE061	07091BE061	07091AE071	07091BE071	07091GE071	07091HE071	070910E061	3-3/4	1-7/8	2-1/4
3/4	07091AF061	07091BF061	07091AF071	07091BF071	07091GF071	07091HF071	070910F061	4	2	2-3/8
1	07091A1061	07091B1061	07091A1071	07091B1071	07091G1071	07091H1071	0709101061	4-1/4	2-1/8	2-5/8
1-1/2	07091A2061	07091B2061	07091A2071	07091B2071	07091G2071	07091H2071	0709102061	4-3/4	2-3/8	2-7/8
2	07091A3061	07091B3061	07091A3071	07091B3071	07091G3071	07091H3071	0709103061	5-3/4	2-7/8	3-3/8
2-1/2	07091A4061	07091B4061	07091A4071	07091B4071	07091G4071	07091H4071	0709104061	6-1/4	3-1/8	3-5/8
3	07091A5061	07091B5061	07091A5071	07091B5071	07091G5071	07091H5071	0709105061	6-3/4	3-3/8	3-7/8
4	07091A6061	07091B6061	07091A6071	07091B6071	07091G6071	07091H6071	0709106061	8-1/4	4-1/8	4-3/4
6	07091A7061	07091B7061	07091A7071	07091B7071	07091G7071	07091H7071	0709107061	11-1/4	5-5/8	7-1/8

## TEE / RUN FERRULE T316L BPE

SIZE (in)	20 Ra (SFF1)		15 Ra-EP (SFF4)		10 Ra MAX-EP		Unpolished	A	B	C
	#3 (PC)	#7 (PL)	#3E (PD)	#7E (PM)	#3E (PJ)	#7E (PR)	#0 (PU)	in	in	in
1/2	07019AE061	07019BE061	07019AE071	07019BE071	07019GE071	07019HE071	070190E061	4-1/8	1-7/8	2-1/4
3/4	07019AF061	07019BF061	07019AF071	07019BF071	07019GF071	07019HF071	070190F061	4-3/8	2	2-3/8
1	07019A1061	07019B1061	07019A1071	07019B1071	07019G1071	07019H1071	0701901061	4-3/4	2-1/8	2-5/8
1-1/2	07019A2061	07019B2061	07019A2071	07019B2071	07019G2071	07019H2071	0701902061	5-1/4	2-3/8	2-7/8
2	07019A3061	07019B3061	07019A3071	07019B3071	07019G3071	07019H3071	0701903061	6-1/4	2-7/8	3-3/8
2-1/2	07019A4061	07019B4061	07019A4071	07019B4071	07019G4071	07019H4071	0701904061	6-3/4	3-1/8	3-5/8
3	07019A5061	07019B5061	07019A5071	07019B5071	07019G5071	07019H5071	0701905061	7-1/4	3-3/8	3-7/8
4	07019A6061	07019B6061	07019A6071	07019B6071	07019G6071	07019H6071	0701906061	8-7/8	4-1/8	4-3/4
6	07019A7061	07019B7061	07019A7071	07019B7071	07019G7071	07019H7071	0701907061	12-3/4	5-5/8	7-1/8

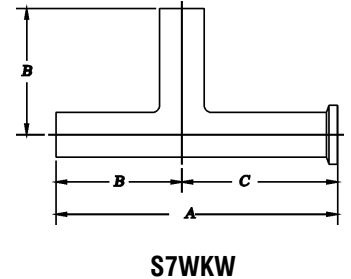

## SHORT RUN TEE T316L BPE

SIZE (in)	20 Ra (SFF1)		15 Ra-EP (SFF4)		10 Ra MAX-EP		Unpolished	A	B	C
	#3 (PC)	#7 (PL)	#3E (PD)	#7E (PM)	#3E (PJ)	#7E (PR)	#0 (PU)	in	in	in
1/2	07119AE061	07119BE061	07119AE071	07119BE071	07119GE071	07119HE071	071190E061	2-3/4	1-7/8	7/8
3/4	07119AF061	07119BF061	07119AF071	07119BF071	07119GF071	07119HF071	071190F061	3	2	1
1	07119A1061	07119B1061	07119A1071	07119B1071	07119G1071	07119H1071	0711901061	3-1/4	2-1/8	1-1/8
1-1/2	07119A2061	07119B2061	07119A2071	07119B2071	07119G2071	07119H2071	0711902061	3-3/4	2-3/8	1-3/8
2	07119A3061	07119B3061	07119A3071	07119B3071	07119G3071	07119H3071	0711903061	4-1/2	2-7/8	1-5/8
2-1/2	07119A4061	07119B4061	07119A4071	07119B4071	07119G4071	07119H4071	0711904061	5	3-1/8	1-7/8
3	07119A5061	07119B5061	07119A5071	07119B5071	07119G5071	07119H5071	0711905061	5-1/2	3-3/8	2-1/8
4	07119A6061	07119B6061	07119A6071	07119B6071	07119G6071	07119H6071	0711906061	6-7/8	4-1/8	2-3/4
6	07119A7061	07119B7061	07119A7071	07119B7071	07119G7071	07119H7071	0711907061	10-1/4	5-5/8	4-5/8

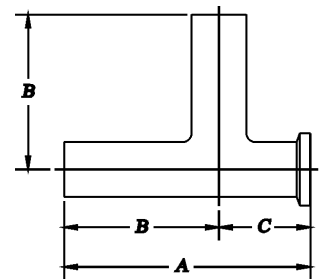

**REDUCING TEE T316L BPE**

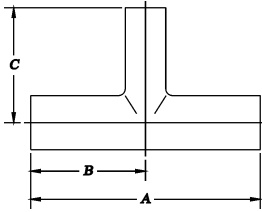

**S7RWWW**

SIZE (in)	20 Ra (SFF1)		15 Ra-EP (SFF4)		10 Ra MAX-EP		Unpolished	A	B	C
	#3 (PC)	#7 (PL)	#3E (PD)	#7E (PM)	#3E (PJ)	#7E (PR)	#0 (PU)	in	in	in
3/4 x 1/2	07590AFE61	07590BFE61	07590AFE71	07590BFE71	07590GFE71	07590HFE71	075900FE61	4	2	2
1 x 1/2	07590A1E61	07590B1E61	07590A1E71	07590B1E71	07590G1E71	07590H1E71	0759001E61	4-1/4	2-1/8	2-1/8
1 x 3/4	07590A1F61	07590B1F61	07590A1F71	07590B1F71	07590G1F71	07590H1F71	0759001F61	4-1/4	2-1/8	2-1/8
1-1/2 x 1/2	07590A2E61	07590B2E61	07590A2E71	07590B2E71	07590G2E71	07590H2E71	0759002E61	4-3/4	2-3/8	2-3/8
1-1/2 x 3/4	07590A2F61	07590B2F61	07590A2F71	07590B2F71	07590G2F71	07590H2F71	0759002F61	4-3/4	2-3/8	2-3/8
1-1/2 x 1	07590A2161	07590B2161	07590A2171	07590B2171	07590G2171	07590H2171	0759002161	4-3/4	2-3/8	2-3/8
2 x 1/2	07590A3E61	07590B3E61	07590A3E71	07590B3E71	07590G3E71	07590H3E71	0759003E61	5-3/4	2-7/8	2-5/8
2 x 3/4	07590A3F61	07590B3F61	07590A3F71	07590B3F71	07590G3F71	07590H3F71	0759003F61	5-3/4	2-7/8	2-5/8
2 x 1	07590A3161	07590B3161	07590A3171	07590B3171	07590G3171	07590H3171	0759003161	5-3/4	2-7/8	2-5/8
2 x 1-1/2	07590A3261	07590B3261	07590A3271	07590B3271	07590G3271	07590H3271	0759003261	5-3/4	2-7/8	2-5/8
2-1/2 x 1/2	07590A4E61	07590B4E61	07590A4E71	07590B4E71	07590G4E71	07590H4E71	0759004E61	6-1/4	3-1/8	2-7/8
2-1/2 x 3/4	07590A4F61	07590B4F61	07590A4F71	07590B4F71	07590G4F71	07590H4F71	0759004F61	6-1/4	3-1/8	2-7/8
2-1/2 x 1	07590A4161	07590B4161	07590A4171	07590B4171	07590G4171	07590H4171	0759004161	6-1/4	3-1/8	2-7/8
2-1/2 x 1-1/2	07590A4261	07590B4261	07590A4271	07590B4271	07590G4271	07590H4271	0759004261	6-1/4	3-1/8	2-7/8
2-1/2 x 2	07590A4361	07590B4361	07590A4371	07590B4371	07590G4371	07590H4371	0759004361	6-1/4	3-1/8	2-7/8
3 x 1/2	07590A5E61	07590B5E61	07590A5E71	07590B5E71	07590G5E71	07590H5E71	0759005E61	6-3/4	3-3/8	3-1/8
3 x 3/4	07590A5F61	07590B5F61	07590A5F71	07590B5F71	07590G5F71	07590H5F71	0759005F61	6-3/4	3-3/8	3-1/8
3 x 1	07590A5161	07590B5161	07590A5171	07590B5171	07590G5171	07590H5171	0759005161	6-3/4	3-3/8	3-1/8
3 x 1-1/2	07590A5261	07590B5261	07590A5271	07590B5271	07590G5271	07590H5271	0759005261	6-3/4	3-3/8	3-1/8
3 x 2	07590A5361	07590B5361	07590A5371	07590B5371	07590G5371	07590H5371	0759005361	6-3/4	3-3/8	3-1/8
3 x 2-1/2	07590A5461	07590B5461	07590A5471	07590B5471	07590G5471	07590H5471	0759005461	6-3/4	3-3/8	3-1/8
4 x 1/2	07590A6E61	07590B6E61	07590A6E71	07590B6E71	07590G6E71	07590H6E71	0759006E61	8-1/4	4-1/8	3-5/8
4 x 3/4	07590A6F61	07590B6F61	07590A6F71	07590B6F71	07590G6F71	07590H6F71	0759006F61	8-1/4	4-1/8	3-5/8
4 x 1	07590A6161	07590B6161	07590A6171	07590B6171	07590G6171	07590H6171	0759006161	8-1/4	4-1/8	3-5/8
4 x 1-1/2	07590A6261	07590B6261	07590A6271	07590B6271	07590G6271	07590H6271	0759006261	8-1/4	4-1/8	3-5/8
4 x 2	07590A6361	07590B6361	07590A6371	07590B6371	07590G6371	07590H6371	0759006361	8-1/4	4-1/8	3-7/8
4 x 2-1/2	07590A6461	07590B6461	07590A6471	07590B6471	07590G6471	07590H6471	0759006461	8-1/4	4-1/8	3-7/8
4 x 3	07590A6561	07590B6561	07590A6571	07590B6571	07590G6571	07590H6571	0759006561	8-1/4	4-1/8	3-7/8
6 x 4*	07590A7661	07590B7661	07590A7671	07590B7671	07590G7671	07590H7671	0759007661	11-1/4	5-5/8	5-1/8

\*Other sizes available

## REDUCING TEE \ BRANCH FERRULE T316L BPE

SIZE (in)	20 Ra (SFF1)		15 Ra-EP (SFF4)		10 Ra MAX-EP		Unpolished	A	B	C
	#3 (PC)	#7 (PL)	#3E (PD)	#7E (PM)	#3E (PJ)	#7E (PR)	#0 (PU)	in	in	in
3/4 x 1/2	07491AFE61	07491BFE61	07491AFE71	07491BFE71	07491GFE71	07491HFE71	074910FE61	4	2	2
1 x 1/2	07491A1E61	07491B1E61	07491A1E71	07491B1E71	07491G1E71	07491H1E71	0749101E61	4-1/4	2-1/8	2-5/8
1 x 3/4	07491A1F61	07491B1F61	07491A1F71	07491B1F71	07491G1F71	07491H1F71	0749101F61	4-1/4	2-1/8	2-5/8
1-1/2 x 1/2	07491A2E61	07491B2E61	07491A2E71	07491B2E71	07491G2E71	07491H2E71	0749102E61	4-3/4	2-3/8	2-7/8
1-1/2 x 3/4	07491A2F61	07491B2F61	07491A2F71	07491B2F71	07491G2F71	07491H2F71	0749102F61	4-3/4	2-3/8	2-7/8
1-1/2 x 1	07491A2161	07491B2161	07491A2171	07491B2171	07491G2171	07491H2171	0749102161	4-3/4	2-3/8	2-7/8
2 x 1/2	07491A3E61	07491B3E61	07491A3E71	07491B3E71	07491G3E71	07491H3E71	0749103E61	5-3/4	2-7/8	3-1/8
2 x 3/4	07491A3F61	07491B3F61	07491A3F71	07491B3F71	07491G3F71	07491H3F71	0749103F61	5-3/4	2-7/8	3-1/8
2 x 1	07491A3161	07491B3161	07491A3171	07491B3171	07491G3171	07491H3171	0749103161	5-3/4	2-7/8	3-1/8
2 x 1-1/2	07491A3261	07491B3261	07491A3271	07491B3271	07491G3271	07491H3271	0749103261	5-3/4	2-7/8	3-1/8
2-1/2 x 1/2	07491A4E61	07491B4E61	07491A4E71	07491B4E71	07491G4E71	07491H4E71	0749104E61	6-1/4	3-1/8	3-3/8
2-1/2 x 3/4	07491A4F61	07491B4F61	07491A4F71	07491B4F71	07491G4F71	07491H4F71	0749104F61	6-1/4	3-1/8	3-3/8
2-1/2 x 1	07491A4161	07491B4161	07491A4171	07491B4171	07491G4171	07491H4171	0749104161	6-1/4	3-1/8	3-3/8
2-1/2 x 1-1/2	07491A4261	07491B4261	07491A4271	07491B4271	07491G4271	07491H4271	0749104261	6-1/4	3-1/8	3-3/8
2-1/2 x 2	07491A4361	07491B4361	07491A4371	07491B4371	07491G4371	07491H4371	0749104361	6-1/4	3-1/8	3-3/8
3 x 1/2	07491A5E61	07491B5E61	07491A5E71	07491B5E71	07491G5E71	07491H5E71	0749105E61	6-3/4	3-3/8	3-5/8
3 x 3/4	07491A5F61	07491B5F61	07491A5F71	07491B5F71	07491G5F71	07491H5F71	0749105F61	6-3/4	3-3/8	3-5/8
3 x 1	07491A5161	07491B5161	07491A5171	07491B5171	07491G5171	07491H5171	0749105161	6-3/4	3-3/8	3-5/8
3 x 1-1/2	07491A5261	07491B5261	07491A5271	07491B5271	07491G5271	07491H5271	0749105261	6-3/4	3-3/8	3-5/8
3 x 2	07491A5361	07491B5361	07491A5371	07491B5371	07491G5371	07491H5371	0749105361	6-3/4	3-3/8	3-5/8
3 x 2-1/2	07491A5461	07491B5461	07491A5471	07491B5471	07491G5471	07491H5471	0749105461	6-3/4	3-3/8	3-5/8
4 x 1/2	07491A6E61	07491B6E61	07491A6E71	07491B6E71	07491G6E71	07491H6E71	0749106E61	8-1/4	4-1/8	4-1/8
4 x 3/4	07491A6F61	07491B6F61	07491A6F71	07491B6F71	07491G6F71	07491H6F71	0749106F61	8-1/4	4-1/8	4-1/8
4 x 1	07491A6161	07491B6161	07491A6171	07491B6171	07491G6171	07491H6171	0749106161	8-1/4	4-1/8	4-1/8
4 x 1-1/2	07491A6261	07491B6261	07491A6271	07491B6271	07491G6271	07491H6271	0749106261	8-1/4	4-1/8	4-1/8
4 x 2	07491A6361	07491B6361	07491A6371	07491B6371	07491G6371	07491H6371	0749106361	8-1/4	4-1/8	4-3/8
4 x 2-1/2	07491A6461	07491B6461	07491A6471	07491B6471	07491G6471	07491H6471	0749106461	8-1/4	4-1/8	4-3/8
4 x 3	07491A6561	07491B6561	07491A6571	07491B6571	07491G6571	07491H6571	0749106561	8-1/4	4-1/8	4-3/8
6 x 4*	07491A7661	07491B7661	07491A7671	07491B7671	07491G7671	07491H7671	0749107661	11-1/4	5-5/8	5-5/8

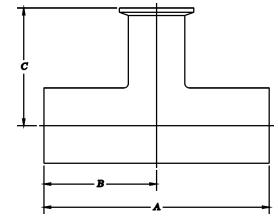

**S7RWWK**

\*Other sizes available

**CROSS T316L BPE**

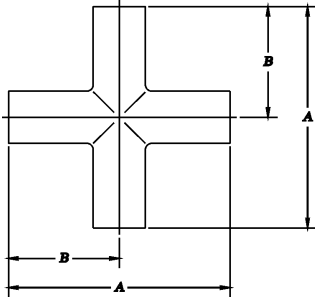

**S9WWWW**

SIZE (in)	20 Ra (SFF1)		15 Ra-EP (SFF4)		10 Ra MAX-EP		Unpolished #0 (PU)	A in	B in
	#3 (PC)	#7 (PL)	#3E (PD)	#7E (PM)	#3E (PJ)	#7E (PR)			
1/2	09090AE061	09090BE061	09090AE071	09090BE071	09090GE071	09090HE071	090900E061	3-3/4	1-7/8
3/4	09090AF061	09090BF061	09090AF071	09090BF071	09090GF071	09090HF071	090900F061	4	2
1	09090A1061	09090B1061	09090A1071	09090B1071	09090G1071	09090H1071	0909001061	4-1/4	2-1/8
1-1/2	09090A2061	09090B2061	09090A2071	09090B2071	09090G2071	09090H2071	0909002061	4-3/4	2-3/8
2	09090A3061	09090B3061	09090A3071	09090B3071	09090G3071	09090H3071	0909003061	5-3/4	2-7/8
2-1/2	09090A4061	09090B4061	09090A4071	09090B4071	09090G4071	09090H4071	0909004061	6-1/4	3-1/8
3	09090A5061	09090B5061	09090A5071	09090B5071	09090G5071	09090H5071	0909005061	6-3/4	3-3/8
4	09090A6061	09090B6061	09090A6071	09090B6071	09090G6071	09090H6071	0909006061	8-1/4	4-1/8
6	09090A7061	09090B7061	09090A7071	09090B7071	09090G7071	09090H7071	0909007061	11-1/4	5-5/8

**SHORT OUTLET TEE / BRANCH FERRULE T316L BPE**

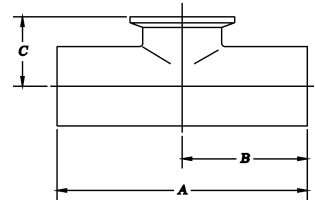

**S7SWWK**

SIZE (in)	20 Ra (SFF1)		15 Ra-EP (SFF4)		10 Ra MAX-EP		Unpolished #0 (PU)	A in	B in	C in
	#3 (PC)	#7 (PL)	#3E (PD)	#7E (PM)	#3E (PJ)	#7E (PR)				
1/2	07191AE061	07191BE061	07191AE071	07191BE071	07191GE071	07191HE071	071910E061	3-3/4	1-7/8	1
3/4	07191AF061	07191BF061	07191AF071	07191BF071	07191GF071	07191HF071	071910F061	4	2	1-1/8
1	07191A1061	07191B1061	07191A1071	07191B1071	07191G1071	07191H1071	0719101061	4-1/4	2-1/8	1-1/8
1-1/2	07191A2061	07191B2061	07191A2071	07191B2071	07191G2071	07191H2071	0719102061	4-3/4	2-3/8	1-3/8
2	07191A3061	07191B3061	07191A3071	07191B3071	07191G3071	07191H3071	0719103061	5-3/4	2-7/8	1-5/8
2-1/2	07191A4061	07191B4061	07191A4071	07191B4071	07191G4071	07191H4071	0719104061	6-1/4	3-1/8	1-7/8
3	07191A5061	07191B5061	07191A5071	07191B5071	07191G5071	07191H5071	0719105061	6-3/4	3-3/8	2-1/8
4	07191A6061	07191B6061	07191A6071	07191B6071	07191G6071	07191H6071	0719106061	8-1/4	4-1/8	2-3/4
6	07191A7061	07191B7061	07191A7071	07191B7071	07191G7071	07191H7071	0719107061	11-1/4	5-5/8	4-5/8

## REDUCING SHORT OUTLET TEE T316L BPE

SIZE (in)	20 Ra (SFF1)		15 Ra-EP (SFF4)		10 Ra MAX-EP		Unpolished	A	B	C
	#3 (PC)	#7 (PL)	#3E (PD)	#7E (PM)	#3E (PJ)	#7E (PR)	#0 (PU)	in	in	in
3/4 x 1/2	07191AFE61	07191BFE61	07191AFE71	07191BFE71	07191GFE71	07191HFE71	071910FE61	4	2	1
1 x 1/2	07191A1E61	07191B1E61	07191A1E71	07191B1E71	07191G1E71	07191H1E71	0719101E61	4-1/4	2-1/8	1-1/8
1 x 3/4	07191A1F61	07191B1F61	07191A1F71	07191B1F71	07191G1F71	07191H1F71	0719101F61	4-1/4	2-1/8	1-1/8
1-1/2 x 1/2	07191A2E61	07191B2E61	07191A2E71	07191B2E71	07191G2E71	07191H2E71	0719102E61	4-3/4	2-3/8	1-3/8
1-1/2 x 3/4	07191A2F61	07191B2F61	07191A2F71	07191B2F71	07191G2F71	07191H2F71	0719102F61	4-3/4	2-3/8	1-3/8
1-1/2 x 1	07191A2161	07191B2161	07191A2171	07191B2171	07191G2171	07191H2171	0719102161	4-3/4	2-3/8	1-3/8
2 x 1/2	07191A3E61	07191B3E61	07191A3E71	07191B3E71	07191G3E71	07191H3E71	0719103E61	5-3/4	2-7/8	1-5/8
2 x 3/4	07191A3F61	07191B3F61	07191A3F71	07191B3F71	07191G3F71	07191H3F71	0719103F61	5-3/4	2-7/8	1-5/8
2 x 1	07191A3161	07191B3161	07191A3171	07191B3171	07191G3171	07191H3171	0719103161	5-3/4	2-7/8	1-5/8
2 x 1-1/2	07191A3261	07191B3261	07191A3271	07191B3271	07191G3271	07191H3271	0719103261	5-3/4	2-7/8	1-5/8
2-1/2 x 1/2	07191A4E61	07191B4E61	07191A4E71	07191B4E71	07191G4E71	07191H4E71	0719104E61	5-3/4	2-7/8	1-5/8
2-1/2 x 3/4	07191A4F61	07191B4F61	07191A4F71	07191B4F71	07191G4F71	07191H4F71	0719104F61	5-3/4	2-7/8	1-5/8
2-1/2 x 1	07191A4161	07191B4161	07191A4171	07191B4171	07191G4171	07191H4171	0719104161	6-1/4	3-1/8	1-7/8
2-1/2 x 1-1/2	07191A4261	07191B4261	07191A4271	07191B4271	07191G4271	07191H4271	0719104261	6-1/4	3-1/8	1-7/8
2-1/2 x 2	07191A4361	07191B4361	07191A4371	07191B4371	07191G4371	07191H4371	0719104361	6-1/4	3-1/8	1-7/8
3 x 1/2	07191A5E61	07191B5E61	07191A5E71	07191B5E71	07191G5E71	07191H5E71	0719105E61	6-3/4	3-3/8	2-1/8
3 x 3/4	07191A5F61	07191B5F61	07191A5F71	07191B5F71	07191G5F71	07191H5F71	0719105F61	6-3/4	3-3/8	2-1/8
3 x 1	07191A5161	07191B5161	07191A5171	07191B5171	07191G5171	07191H5171	0719105161	6-3/4	3-3/8	2-1/8
3 x 1-1/2	07191A5261	07191B5261	07191A5271	07191B5271	07191G5271	07191H5271	0719105261	6-3/4	3-3/8	2-1/8
3 x 2	07191A5361	07191B5361	07191A5371	07191B5371	07191G5371	07191H5371	0719105361	6-3/4	3-3/8	2-1/8
3 x 2-1/2	07191A5461	07191B5461	07191A5471	07191B5471	07191G5471	07191H5471	0719105461	6-3/4	3-3/8	2-1/8
4 x 1/2	07191A6E61	07191B6E61	07191A6E71	07191B6E71	07191G6E71	07191H6E71	0719106E61	8-1/4	4-1/8	2-5/8
4 x 3/4	07191A6F61	07191B6F61	07191A6F71	07191B6F71	07191G6F71	07191H6F71	0719106F61	8-1/4	4-1/8	2-5/8
4 x 1	07191A6161	07191B6161	07191A6171	07191B6171	07191G6171	07191H6171	0719106161	8-1/4	4-1/8	2-5/8
4 x 1-1/2	07191A6261	07191B6261	07191A6271	07191B6271	07191G6271	07191H6271	0719106261	8-1/4	4-1/8	2-5/8
4 x 2	07191A6361	07191B6361	07191A6371	07191B6371	07191G6371	07191H6371	0719106361	8-1/4	4-1/8	2-5/8
4 x 2-1/2	07191A6461	07191B6461	07191A6471	07191B6471	07191G6471	07191H6471	0719106461	8-1/4	4-1/8	2-5/8
4 x 3	07191A6561	07191B6561	07191A6571	07191B6571	07191G6571	07191H6571	0719106561	8-1/4	4-1/8	2-5/8
6 x 4*	07191A7661	07191B7661	07191A7671	07191B7671	07191G7671	07191H7671	0719107661	11-1/4	5-5/8	3-3/4

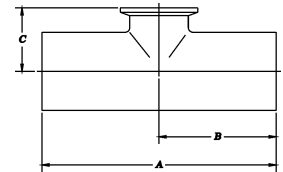

**S7RSWWK**

\*Other sizes available

**INSTRUMENT TEE T316L BPE**

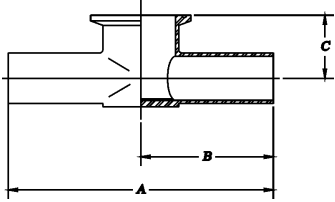

**S7RSGT**

SIZE (in)	20 Ra (SFF1)	15 Ra-EP (SFF4)	10 Ra MAX EP	A	B	C
	#7 (PL)	#7E (PM)	#7E (PR)	in	in	in
1/2 x 1-1/2	07690BE261	07690BE271	07690HE271	2-1/2	5	7/8
3/4 x 1-1/2	07690BF261	07690BF271	07690HF271	2-1/2	5	1
1 x 1-1/2	07690B1261	07690B1271	07690H1271	2-1/2	5	1-1/8
1/2 x 2	07690BE361	07690BE371	07690HE371	2-3/4	5-1/2	1
3/4 x 2	07690BF361	07690BF371	07690HF371	2-3/4	5-1/2	1-1/8
1 x 2	07690B1361	07690B1371	07690H1371	2-3/4	5-1/2	1-1/4
1-1/2 x 2	07690B2361	07690B2371	07690H2371	2-3/4	5-1/2	1-1/2

## REDUCING CROSS T316L BPE

SIZE (in)	20 Ra (SFF1)		15 Ra-EP (SFF4)		10 Ra MAX-EP		Unpolished	A	B	C	D
	#3 (PC)	#7 (PL)	#3E (PD)	#7E (PM)	#3E (PJ)	#7E (PR)	#0 (PU)	in	in	in	in
3/4 x 1/2	09090AFE61	09090BFE61	09090AFE71	09090BFE71	09090GFE71	09090HFE71	090900FE61	4	2	4	2
1 x 1/2	09090A1E61	09090B1E61	09090A1E71	09090B1E71	09090G1E71	09090H1E71	0909001E61	4-1/4	2-1/8	4-1/4	2-1/8
1 x 3/4	09090A1F61	09090B1F61	09090A1F71	09090B1F71	09090G1F71	09090H1F71	0909001F61	4-1/4	2-1/8	4-1/4	2-1/8
1-1/2 x 1/2	09090A2E61	09090B2E61	09090A2E71	09090B2E71	09090G2E71	09090H2E71	0909002E61	4-3/4	2-3/8	4-3/4	2-3/8
1-1/2 x 3/4	09090A2F61	09090B2F61	09090A2F71	09090B2F71	09090G2F71	09090H2F71	0909002F61	4-3/4	2-3/8	4-3/4	2-3/8
1-1/2 x 1	09090A2161	09090B2161	09090A2171	09090B2171	09090G2171	09090H2171	0909002161	4-3/4	2-3/8	4-3/4	2-3/8
2 x 1/2	09090A3E61	09090B3E61	09090A3E71	09090B3E71	09090G3E71	09090H3E71	0909003E61	5-3/4	2-7/8	5-1/4	2-5/8
2 x 3/4	09090A3F61	09090B3F61	09090A3F71	09090B3F71	09090G3F71	09090H3F71	0909003F61	5-3/4	2-7/8	5-1/4	2-5/8
2 x 1	09090A3161	09090B3161	09090A3171	09090B3171	09090G3171	09090H3171	0909003161	5-3/4	2-7/8	5-1/4	2-5/8
2 x 1-1/2	09090A3261	09090B3261	09090A3271	09090B3271	09090G3271	09090H3271	0909003261	5-3/4	2-7/8	5-1/4	2-5/8
2-1/2 x 1/2	09090A4E61	09090B4E61	09090A4E71	09090B4E71	09090G4E71	09090H4E71	0909004E61	6-1/4	3-1/8	5-3/4	2-7/8
2-1/2 x 3/4	09090A4F61	09090B4F61	09090A4F71	09090B4F71	09090G4F71	09090H4F71	0909004F61	6-1/4	3-1/8	5-3/4	2-7/8
2-1/2 x 1	09090A4161	09090B4161	09090A4171	09090B4171	09090G4171	09090H4171	0909004161	6-1/4	3-1/8	5-3/4	2-7/8
2-1/2 x 1-1/2	09090A4261	09090B4261	09090A4271	09090B4271	09090G4271	09090H4271	0909004261	6-1/4	3-1/8	5-3/4	2-7/8
2-1/2 x 2	09090A4361	09090B4361	09090A4371	09090B4371	09090G4371	09090H4371	0909004361	6-1/4	3-1/8	5-3/4	2-7/8
3 x 1/2	09090A5E61	09090B5E61	09090A5E71	09090B5E71	09090G5E71	09090H5E71	0909005E61	6-3/4	3-3/8	6-1/4	3-1/8
3 x 3/4	09090A5F61	09090B5F61	09090A5F71	09090B5F71	09090G5F71	09090H5F71	0909005F61	6-3/4	3-3/8	6-1/4	3-1/8
3 x 1	09090A5161	09090B5161	09090A5171	09090B5171	09090G5171	09090H5171	0909005161	6-3/4	3-3/8	6-1/4	3-1/8
3 x 1-1/2	09090A5261	09090B5261	09090A5271	09090B5271	09090G5271	09090H5271	0909005261	6-3/4	3-3/8	6-1/4	3-1/8
3 x 2	09090A5361	09090B5361	09090A5371	09090B5371	09090G5371	09090H5371	0909005361	6-3/4	3-3/8	6-1/4	3-1/8
3 x 2-1/2	09090A5461	09090B5461	09090A5471	09090B5471	09090G5471	09090H5471	0909005461	6-3/4	3-3/8	6-1/4	3-1/8
4 x 1/2	09090A6E61	09090B6E61	09090A6E71	09090B6E71	09090G6E71	09090H6E71	0909006E61	8-1/4	4-1/8	7-1/4	3-5/8
4 x 3/4	09090A6F61	09090B6F61	09090A6F71	09090B6F71	09090G6F71	09090H6F71	0909006F61	8-1/4	4-1/8	7-1/4	3-5/8
4 x 1	09090A6161	09090B6161	09090A6171	09090B6171	09090G6171	09090H6171	0909006161	8-1/4	4-1/8	7-1/4	3-5/8
4 x 1-1/2	09090A6261	09090B6261	09090A6271	09090B6271	09090G6271	09090H6271	0909006261	8-1/4	4-1/8	7-1/4	3-5/8
4 x 2	09090A6361	09090B6361	09090A6371	09090B6371	09090G6371	09090H6371	0909006361	8-1/4	4-1/8	7-1/4	3-5/8
4 x 2-1/2	09090A6461	09090B6461	09090A6471	09090B6471	09090G6471	09090H6471	0909006461	8-1/4	4-1/8	7-1/4	3-5/8
4 x 3	09090A6561	09090B6561	09090A6571	09090B6571	09090G6571	09090H6571	0909006561	8-1/4	4-1/8	7-1/4	3-5/8
6 x 4*	09090A7661	09090B7661	09090A7671	09090B7671	09090G7671	09090H7671	0909007661	8-1/4	4-1/8	7-1/4	3-5/8

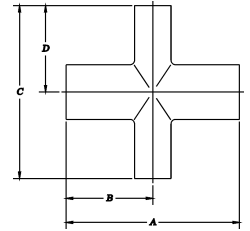

S9RWWWW

\*Other sizes available

**WELDING FERRULE T316L BPE**

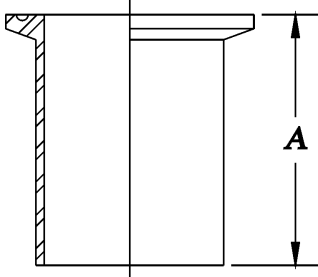

**S14AWF**

SIZE (in)	20 Ra (SFF1)	15 Ra-EP (SFF4)	10 Ra-MAX EP	A
	#7 (PL)	#7E (PM)	#7E (PR)	in
1/2	14090BE061	14090BE071	14090HE071	1-3/4
3/4	14090BF061	14090BF071	14090HF071	1-3/4
1	14090B1061	14090B1071	14090H1071	1-3/4
1-1/2	14090B2061	14090B2071	14090H2071	1-3/4
2	14090B3061	14090B3071	14090H3071	2-1/4
2-1/2	14090B4061	14090B4071	14090H4071	2-1/4
3	14090B5061	14090B5071	14090H5071	2-1/4
4	14090B6061	14090B6071	14090H6071	2-1/4
6	14090B7061	14090B7071	14090H7071	3

**WELDING CAP T316L BPE**

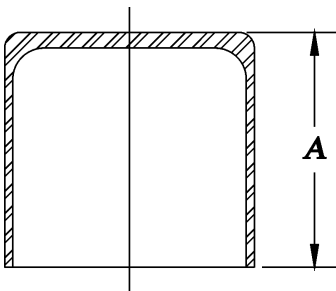

**S16AWF**

SIZE (in)	20 Ra (SFF1)	15 Ra-EP (SFF4)	10 Ra-MAX EP	A
	#7 (PL)	#7E (PM)	#7E (PR)	in
1/2	16090BE061	16090BE071	16090HE071	1-1/2
3/4	16090BF061	16090BF071	16090HF071	1-1/2
1	16090B1061	16090B1071	16090H1071	1-1/2
1-1/2	16090B2061	16090B2071	16090H2071	1-1/2
2	16090B3061	16090B3071	16090H3071	1-1/2
2-1/2	16090B4061	16090B4071	16090H4071	1-1/2
3	16090B5061	16090B5071	16090H5071	1-3/4
4	16090B6061	16090B6071	16090H6071	2
6	14090B7061	14090B7071	14090H7071	2-1/2

## CONCENTRIC REDUCER T316L BPE

SIZE (in)	20 Ra (SFF1)		15 Ra-EP (SFF4)		10 Ra MAX-EP		Unpolished	A
	#3 (PC)	#7 (PL)	#3E (PD)	#7E (PM)	#3E (PJ)	#7E (PR)	#0 (PU)	in
3/4 x 1/2	31090AFE61	31090BFE61	31090AFE71	31090BFE71	31090GFE71	31090HFE71	310900FE61	4
1 x 1/2	31090A1E61	31090B1E61	31090A1E71	31090B1E71	31090G1E71	31090H1E71	3109001E61	4-1/2
1 x 3/4	31090A1F61	31090B1F61	31090A1F71	31090B1F71	31090G1F71	31090H1F71	3109001F61	4-1/2
1-1/2 x 1/2	31090A2E61	31090B2E61	31090A2E71	31090B2E71	31090G2E71	31090H2E71	3109002E61	5-1/2
1-1/2 x 3/4	31090A2F61	31090B2F61	31090A2F71	31090B2F71	31090G2F71	31090H2F71	3109002F61	5
1-1/2 x 1	31090A2161	31090B2161	31090A2171	31090B2171	31090G2171	31090H2171	3109002161	5
2 x 1/2	31090A3E61	31090B3E61	31090A3E71	31090B3E71	31090G3E71	31090H3E71	3109003E61	7-3/4
2 x 3/4	31090A3F61	31090B3F61	31090A3F71	31090B3F71	31090G3F71	31090H3F71	3109003F61	7-1/4
2 x 1	31090A3161	31090B3161	31090A3171	31090B3171	31090G3171	31090H3171	3109003161	7-1/4
2 x 1-1/2	31090A3261	31090B3261	31090A3271	31090B3271	31090G3271	31090H3271	3109003261	5-1/4
2-1/2 x 1/2	31090A4E61	31090B4E61	31090A4E71	31090B4E71	31090G4E71	31090H4E71	3109004E61	9-3/4
2-1/2 x 3/4	31090A4F61	31090B4F61	31090A4F71	31090B4F71	31090G4F71	31090H4F71	3109004F61	9-1/4
2-1/2 x 1	31090A4161	31090B4161	31090A4171	31090B4171	31090G4171	31090H4171	3109004161	9-1/4
2-1/2 x 1-1/2	31090A4261	31090B4261	31090A4271	31090B4271	31090G4271	31090H4271	3109004261	7-1/4
2-1/2 x 2	31090A4361	31090B4361	31090A4371	31090B4371	31090G4371	31090H4371	3109004361	5-1/2
3 x 1	31090A5161	31090B5161	31090A5171	31090B5171	31090G5171	31090H5171	3109005161	11-1/4
3 x 1-1/2	31090A5261	31090B5261	31090A5271	31090B5271	31090G5271	31090H5271	3109005261	9-1/4
3 x 2	31090A5361	31090B5361	31090A5371	31090B5371	31090G5371	31090H5371	3109005361	7-1/2
3 x 2-1/2	31090A5461	31090B5461	31090A5471	31090B5471	31090G5471	31090H5471	3109005461	5-1/2
4 x 1	31090A6161	31090B6161	31090A6171	31090B6171	31090G6171	31090H6171	3109006161	15-1/2
4 x 1-1/2	31090A6261	31090B6261	31090A6271	31090B6271	31090G6271	31090H6271	3109006261	13-1/2
4 x 2	31090A6361	31090B6361	31090A6371	31090B6371	31090G6371	31090H6371	3109006361	11-3/4
4 x 2-1/2	31090A6461	31090B6461	31090A6471	31090B6471	31090G6471	31090H6471	3109006461	9-3/4
4 x 3	31090A6561	31090B6561	31090A6571	31090B6571	31090G6571	31090H6571	3109006561	7-3/4
6 x 4*	31090A7661	31090B7661	31090A7671	31090B7671	31090G7671	31090H7671	3109007661	10

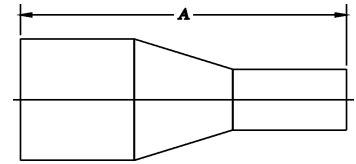

S31

\*Other sizes available

**CONCENTRIC REDUCER / FERRULE LARGE END T316L BPE**

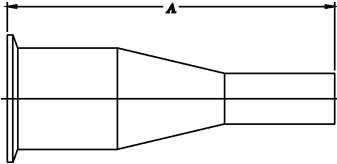

**S31K**

SIZE (in)	20 Ra (SFF1)		15 Ra-EP (SFF4)		10 Ra MAX-EP (SFF4)		Unpolished #0 (PU)	A in
	#3 (PC)	#7 (PL)	#3E (PD)	#7E (PM)	#3E (PJ)	#7E (PR)		
3/4 x 1/2	31019AFE61	31019BFE61	31019AFE71	31019BFE71	31019GFE71	31019HFE71	310190FE61	3
1 x 1/2	31019A1E61	31019B1E61	31019A1E71	31019B1E71	31019G1E71	31019H1E71	3101901E61	3-1/2
1 x 3/4	31019A1F61	31019B1F61	31019A1F71	31019B1F71	31019G1F71	31019H1F71	3101901F61	3
1-1/2 x 1/2	31019A2E61	31019B2E61	31019A2E71	31019B2E71	31019G2E71	31019H2E71	3101902E61	4-1/2
1-1/2 x 3/4	31019A2F61	31019B2F61	31019A2F71	31019B2F71	31019G2F71	31019H2F71	3101902F61	4
1-1/2 x 1	31019A2161	31019B2161	31019A2171	31019B2171	31019G2171	31019H2171	3101902161	4
2 x 1/2	31019A3E61	31019B3E61	31019A3E71	31019B3E71	31019G3E71	31019H3E71	3101903E61	6-1/2
2 x 3/4	31019A3F61	31019B3F61	31019A3F71	31019B3F71	31019G3F71	31019H3F71	3101903F61	6
2 x 1	31019A3161	31019B3161	31019A3171	31019B3171	31019G3171	31019H3171	3101903161	6
2 x 1-1/2	31019A3261	31019B3261	31019A3271	31019B3271	31019G3271	31019H3271	3101903261	4
2-1/2 x 1/2	31019A4E61	31019B4E61	31019A4E71	31019B4E71	31019G4E71	31019H4E71	3101904E61	8-1/2
2-1/2 x 3/4	31019A4F61	31019B4F61	31019A4F71	31019B4F71	31019G4F71	31019H4F71	3101904F61	8
2-1/2 x 1	31019A4161	31019B4161	31019A4171	31019B4171	31019G4171	31019H4171	3101904161	8
2-1/2 x 1-1/2	31019A4261	31019B4261	31019A4271	31019B4271	31019G4271	31019H4271	3101904261	6
2-1/2 x 2	31019A4361	31019B4361	31019A4371	31019B4371	31019G4371	31019H4371	3101904361	4-1/4
3 x 1	31019A5161	31019B5161	31019A5171	31019B5171	31019G5171	31019H5171	3101905161	10
3 x 1-1/2	31019A5261	31019B5261	31019A5271	31019B5271	31019G5271	31019H5271	3101905261	8
3 x 2	31019A5361	31019B5361	31019A5371	31019B5371	31019G5371	31019H5371	3101905361	6-1/4
3 x 2-1/2	31019A5461	31019B5461	31019A5471	31019B5471	31019G5471	31019H5471	3101905461	4-1/4
4 x 1	31019A6161	31019B6161	31019A6171	31019B6171	31019G6171	31019H6171	3101906161	14-1/8
4 x 1-1/2	31019A6261	31019B6261	31019A6271	31019B6271	31019G6271	31019H6271	3101906261	12-1/8
4 x 2	31019A6361	31019B6361	31019A6371	31019B6371	31019G6371	31019H6371	3101906361	10-3/8
4 x 2-1/2	31019A6461	31019B6461	31019A6471	31019B6471	31019G6471	31019H6471	3101906461	8-3/8
4 x 3	31019A6561	31019B6561	31019A6571	31019B6571	31019G6571	31019H6571	3101906561	6-3/8
6 x 4*	31019A7661	31019B7661	31019A7671	31019B7671	31019G7671	31019H7671	3101907661	9

\*Other sizes available

## ECCENTRIC REDUCER T316L BPE

SIZE (in)	20 Ra (SFF1)		15 Ra-EP (SFF4)		10 Ra MAX-EP		Unpolished	A
	#3 (PC)	#7 (PL)	#3E (PD)	#7E (PM)	#3E (PJ)	#7E (PR)	#0 (PU)	in
3/4 x 1/2	32090AFE61	32090BFE61	32090AFE71	32090BFE71	32090GFE71	32090HFE71	320900FE61	4
1 x 1/2	32090A1E61	32090B1E61	32090A1E71	32090B1E71	32090G1E71	32090H1E71	3209001E61	4-1/2
1 x 3/4	32090A1F61	32090B1F61	32090A1F71	32090B1F71	32090G1F71	32090H1F71	3209001F61	4-1/2
1-1/2 x 1/2	32090A2E61	32090B2E61	32090A2E71	32090B2E71	32090G2E71	32090H2E71	3209002E61	5-1/2
1-1/2 x 3/4	32090A2F61	32090B2F61	32090A2F71	32090B2F71	32090G2F71	32090H2F71	3209002F61	5
1-1/2 x 1	32090A2161	32090B2161	32090A2171	32090B2171	32090G2171	32090H2171	3209002161	5
2 x 1/2	32090A3E61	32090B3E61	32090A3E71	32090B3E71	32090G3E71	32090H3E71	3209003E61	7-3/4
2 x 3/4	32090A3F61	32090B3F61	32090A3F71	32090B3F71	32090G3F71	32090H3F71	3209003F61	7-1/4
2 x 1	32090A3161	32090B3161	32090A3171	32090B3171	32090G3171	32090H3171	3209003161	7-1/4
2 x 1-1/2	32090A3261	32090B3261	32090A3271	32090B3271	32090G3271	32090H3271	3209003261	5-1/4
2-1/2 x 1/2	32090A4E61	32090B4E61	32090A4E71	32090B4E71	32090G4E71	32090H4E71	3209004E61	9-3/4
2-1/2 x 3/4	32090A4F61	32090B4F61	32090A4F71	32090B4F71	32090G4F71	32090H4F71	3209004F61	9-1/4
2-1/2 x 1	32090A4161	32090B4161	32090A4171	32090B4171	32090G4171	32090H4171	3209004161	9-1/4
2-1/2 x 1-1/2	32090A4261	32090B4261	32090A4271	32090B4271	32090G4271	32090H4271	3209004261	7-1/4
2-1/2 x 2	32090A4361	32090B4361	32090A4371	32090B4371	32090G4371	32090H4371	3209004361	5-1/2
3 x 1	32090A5161	32090B5161	32090A5171	32090B5171	32090G5171	32090H5171	3209005161	11-1/4
3 x 1-1/2	32090A5261	32090B5261	32090A5271	32090B5271	32090G5271	32090H5271	3209005261	9-1/4
3 x 2	32090A5361	32090B5361	32090A5371	32090B5371	32090G5371	32090H5371	3209005361	7-1/2
3 x 2-1/2	32090A5461	32090B5461	32090A5471	32090B5471	32090G5471	32090H5471	3209005461	5-1/2
4 x 1	32090A6161	32090B6161	32090A6171	32090B6171	32090G6171	32090H6171	3209006161	15-1/2
4 x 1-1/2	32090A6261	32090B6261	32090A6271	32090B6271	32090G6271	32090H6271	3209006261	13-1/2
4 x 2	32090A6361	32090B6361	32090A6371	32090B6371	32090G6371	32090H6371	3209006361	11-3/4
4 x 2-1/2	32090A6461	32090B6461	32090A6471	32090B6471	32090G6471	32090H6471	3209006461	9-3/4
4 x 3	32090A6561	32090B6561	32090A6571	32090B6571	32090G6571	32090H6571	3209006561	7-3/4
6 x 4*	32090A7661	32090B7661	32090A7671	32090B7671	32090G7671	32090H7671	3209007661	10

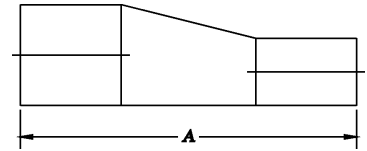

S32

\*Other sizes available

**ECCENTRIC REDUCER / FERRULE LARGE END T316L BPE**

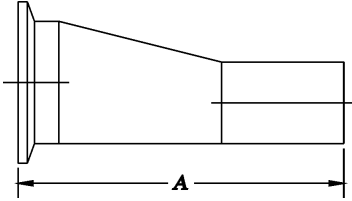

**S32K**

SIZE (in)	20 Ra (SFF1)		15 Ra-EP (SFF4)		10 Ra MAX-EP		Unpolished #0 (PU)	A in
	#3 (PC)	#7 (PL)	#3E (PD)	#7E (PM)	#3E (PJ)	#7E (PR)		
3/4 x 1/2	32019AFE61	32019BFE61	32019AFE71	32019BFE71	32019GFE71	32019HFE71	320190FE61	3
1 x 1/2	32019A1E61	32019B1E61	32019A1E71	32019B1E71	32019G1E71	32019H1E71	3201901E61	3-1/2
1 x 3/4	32019A1F61	32019B1F61	32019A1F71	32019B1F71	32019G1F71	32019H1F71	3201901F61	3
1-1/2 x 1/2	32019A2E61	32019B2E61	32019A2E71	32019B2E71	32019G2E71	32019H2E71	3201902E61	4-1/2
1-1/2 x 3/4	32019A2F61	32019B2F61	32019A2F71	32019B2F71	32019G2F71	32019H2F71	3201902F61	4
1-1/2 x 1	32019A2161	32019B2161	32019A2171	32019B2171	32019G2171	32019H2171	3201902161	4
2 x 1/2	32019A3E61	32019B3E61	32019A3E71	32019B3E71	32019G3E71	32019H3E71	3201903E61	6-1/2
2 x 3/4	32019A3F61	32019B3F61	32019A3F71	32019B3F71	32019G3F71	32019H3F71	3201903F61	6
2 x 1	32019A3161	32019B3161	32019A3171	32019B3171	32019G3171	32019H3171	3201903161	6
2 x 1-1/2	32019A3261	32019B3261	32019A3271	32019B3271	32019G3271	32019H3271	3201903261	4
2-1/2 x 1/2	32019A4E61	32019B4E61	32019A4E71	32019B4E71	32019G4E71	32019H4E71	3201904E61	8-1/2
2-1/2 x 3/4	32019A4F61	32019B4F61	32019A4F71	32019B4F71	32019G4F71	32019H4F71	3201904F61	8
2-1/2 x 1	32019A4161	32019B4161	32019A4171	32019B4171	32019G4171	32019H4171	3201904161	8
2-1/2 x 1-1/2	32019A4261	32019B4261	32019A4271	32019B4271	32019G4271	32019H4271	3201904261	6
2-1/2 x 2	32019A4361	32019B4361	32019A4371	32019B4371	32019G4371	32019H4371	3201904361	4-1/4
3 x 1	32019A5161	32019B5161	32019A5171	32019B5171	32019G5171	32019H5171	3201905161	10
3 x 1-1/2	32019A5261	32019B5261	32019A5271	32019B5271	32019G5271	32019H5271	3201905261	8
3 x 2	32019A5361	32019B5361	32019A5371	32019B5371	32019G5371	32019H5371	3201905361	6-1/4
3 x 2-1/2	32019A5461	32019B5461	32019A5471	32019B5471	32019G5471	32019H5471	3201905461	4-1/4
4 x 1	32019A6161	32019B6161	32019A6171	32019B6171	32019G6171	32019H6171	3201906161	14-1/8
4 x 1-1/2	32019A6261	32019B6261	32019A6271	32019B6271	32019G6271	32019H6271	3201906261	12-1/8
4 x 2	32019A6361	32019B6361	32019A6371	32019B6371	32019G6371	32019H6371	3201906361	10-3/8
4 x 2-1/2	32019A6461	32019B6461	32019A6471	32019B6471	32019G6471	32019H6471	3201906461	8-3/8
4 x 3	32019A6561	32019B6561	32019A6571	32019B6571	32019G6571	32019H6571	3201906561	6-3/8
6 x 4*	32019A7661	32019B7661	32019A7671	32019B7671	32019G7671	32019H7671	3201907661	9

\*Other sizes available

## USE-POINT FITTINGS

SIZE (in)	S2UBWWK - BOTTOM OUTLET				S2USWWK SIDE OUTLET		A in	B in	C in	D in
	20 Ra (SFF1)		15 Ra-EP (SFF4)		20 Ra (SFF1)	15 Ra-EP (SFF4)				
	#3 (PC)	#7 (PL)	#3E (PD)	#7E (PM)	#3 (PC)	#3E (PD)				
3/4 x 1/2	18290AFE61	18290BFE61	18290AFE71	18290BFE71	18190AFE61	18190AFE71	4-1/2	2-1/4	3-3/4	1
1 x 1/2	18290A1E61	18290B1E61	18290A1E71	18290B1E71	18190A1E61	18190A1E71	4-1/2	2-1/4	3-3/4	1-1/8
1 x 3/4	18290A1F61	18290B1F61	18290A1F71	18290B1F71	18190A1F61	18190A1F71	4-1/2	2-1/4	3-3/4	1-1/8
1-1/2 x 1/2	18290A2E61	18290B2E61	18290A2E71	18290B2E71	18190A2E61	18190A2E71	6	3	4-1/2	1-3/8
1-1/2 x 3/4	18290A2F61	18290B2F61	18290A2F71	18290B2F71	18190A2F61	18190A2F71	6	3	4-1/2	1-3/8
1-1/2 x 1	18290A2161	18290B2161	18290A2171	18290B2171	18190A2161	18190A2171	6	3	4-1/2	1-3/8
2 x 1/2	18290A3E61	18290B3E61	18290A3E71	18290B3E71	18190A3E61	18190A3E71	6	3	5	1-5/8
2 x 3/4	18290A3F61	18290B3F61	18290A3F71	18290B3F71	18190A3F61	18190A3F71	6	3	5	1-5/8
2 x 1	18290A3161	18290B3161	18290A3171	18290B3171	18190A3161	18190A3171	6	3	5	1-5/8
2 x 1-1/2	18290A3261	18290B3261	18290A3271	18290B3271	18190A3261	18190A3271	6	3	5	1-5/8
2-1/2 x 1/2	18290A4E61	18290B4E61	18290A4E71	18290B4E71	18190A4E61	18190A4E71	7-1/2	3-3/4	5-3/4	1-7/8
2-1/2 x 3/4	18290A4F61	18290B4F61	18290A4F71	18290B4F71	18190A4F61	18190A4F71	7-1/2	3-3/4	5-3/4	1-7/8
2-1/2 x 1	18290A4161	18290B4161	18290A4171	18290B4171	18190A4161	18190A4171	7-1/2	3-3/4	5-3/4	1-7/8
2-1/2 x 1-1/2	18290A4261	18290B4261	18290A4271	18290B4271	18190A4261	18190A4271	7-1/2	3-3/4	5-3/4	1-7/8
2- 1/2 x 2	18290A4361	18290B4361	18290A4371	18290B4371	18190A4361	18190A4371	7-1/2	3-3/4	5-3/4	1-7/8
3 x 1/2	18290A5E61	18290B5E61	18290A5E71	18290B5E71	18190A5E61	18190A5E71	9	4-1/2	6-1/2	2-1/8
3 x 3/4	18290A5F61	18290B5F61	18290A5F71	18290B5F71	18190A5F61	18190A5F71	9	4-1/2	6-1/2	2-1/8
3 x 1	18290A5161	18290B5161	18290A5171	18290B5171	18190A5161	18190A5171	9	4-1/2	6-1/2	2-1/8
3 x 1-1/2	18290A5261	18290B5261	18290A5271	18290B5271	18190A5261	18190A5271	9	4-1/2	6-1/2	2-1/8
3 x 2	18290A5361	18290B5361	18290A5371	18290B5371	18190A5361	18190A5371	9	4-1/2	6-1/2	2-1/8
3 x 2-1/2	18290A5461	18290B5461	18290A5471	18290B5471	18190A5461	18190A5471	9	4-1/2	6-1/2	2-1/8
4 x 1/2	18290A6E61	18290B6E61	18290A6E71	18290B6E71	18190A6E61	18190A6E71	12	6	8-1/2	2-5/8
4 x 3/4	18290A6F61	18290B6F61	18290A6F71	18290B6F71	18190A6F61	18190A6F71	12	6	8-1/2	2-5/8
4 x 1	18290A6161	18290B6161	18290A6171	18290B6171	18190A6161	18190A6171	12	6	8-1/2	2-5/8
4 x 1-1/2	18290A6261	18290B6261	18290A6271	18290B6271	18190A6261	18190A6271	12	6	8-1/2	2-5/8
4 x 2	18290A6361	18290B6361	18290A6371	18290B6371	18190A6361	18190A6371	12	6	8-1/2	2-5/8
4 x 2-1/2	18290A6461	18290B6461	18290A6471	18290B6471	18190A6461	18190A6471	12	6	8-1/2	2-5/8
4 x 3	18290A6561	18290B6561	18290A6571	18290B6571	18190A6561	18190A6571	12	6	8-1/2	2-5/8

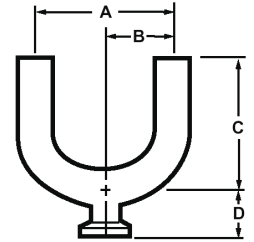

**S2UBWWK  
BOTTOM OUTLET**

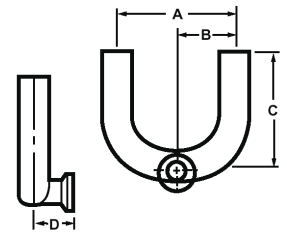

**S2USWWK  
SIDE OUTLET**

## 90 DEGREE ELBOW T316L BPE

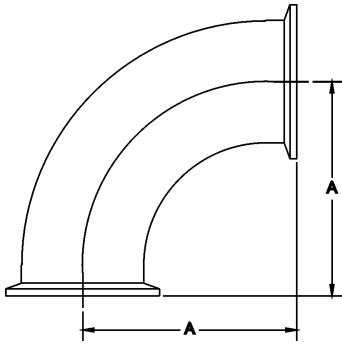

**S2CMP**

SIZE (in)	20 Ra (SFF1)		15 Ra-EP (SFF4)		10 Ra MAX-EP		Unpolished #0 (PU)	A in
	#3 (PC)	#7 (PL)	#3E (PD)	#7E (PM)	#3E (PJ)	#7E (PR)		
1/2	020L0AE061	020L0BE061	020L0AE071	020L0BE071	020L0GE071	020L0HE071	020L00E061	1-5/8
3/4	020L0AF061	020L0BF061	020L0AF071	020L0BF071	020L0GF071	020L0HF071	020L00F061	1-5/8
1	020L0A1061	020L0B1061	020L0A1071	020L0B1071	020L0G1071	020L0H1071	020L001061	2
1-1/2	020L0A2061	020L0B2061	020L0A2071	020L0B2071	020L0G2071	020L0H2071	020L002061	2-3/4
2	020L0A3061	020L0B3061	020L0A3071	020L0B3071	020L0G3071	020L0H3071	020L003061	3-1/2
2-1/2	020L0A4061	020L0B4061	020L0A4071	020L0B4071	020L0G4071	020L0H4071	020L004061	4-1/4
3	020L0A5061	020L0B5061	020L0A5071	020L0B5071	020L0G5071	020L0H5071	020L005061	5
4	020L0A6061	020L0B6061	020L0A6071	020L0B6071	020L0G6071	020L0H6071	020L006061	6-5/8
6	020L0A7061	020L0B7061	020L0A7071	020L0B7071	020L0G7071	020L0H7071	020L007061	10-1/2

## 45 DEGREE ELBOW T316L BPE

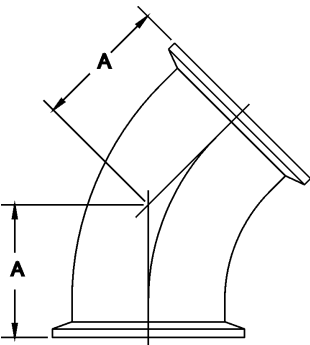

**S2KMP**

SIZE (in)	20 Ra (SFF1)		15 Ra-EP (SFF4)		10 Ra MAX-EP		Unpolished #0 (PU)	A in
	#3 (PC)	#7 (PL)	#3E (PD)	#7E (PM)	#3E (PJ)	#7E (PR)		
1/2	025L0AE061	025L0BE061	025L0AE071	025L0BE071	025L0GE071	025L0HE071	025L00E061	1
3/4	025L0AF061	025L0BF061	025L0AF071	025L0BF071	025L0GF071	025L0HF071	025L00F061	1
1	025L0A1061	025L0B1061	025L0A1071	025L0B1071	025L0G1071	025L0H1071	025L001061	1-1/8
1-1/2	025L0A2061	025L0B2061	025L0A2071	025L0B2071	025L0G2071	025L0H2071	025L002061	1-7/16
2	025L0A3061	025L0B3061	025L0A3071	025L0B3071	025L0G3071	025L0H3071	025L003061	1-3/4
2-1/2	025L0A4061	025L0B4061	025L0A4071	025L0B4071	025L0G4071	025L0H4071	025L004061	2-1/16
3	025L0A5061	025L0B5061	025L0A5071	025L0B5071	025L0G5071	025L0H5071	025L005061	2-3/8
4	025L0A6061	025L0B6061	025L0A6071	025L0B6071	025L0G6071	025L0H6071	025L006061	3-1/8
6	025L0A7061	025L0B7061	025L0A7071	025L0B7071	025L0G7071	025L0H7071	025L007061	5-1/4

# BPE Fittings - Clamp

WCB-Flow Products  
www.spxprocessequipment.com

## TEE T316L BPE

SIZE (in)	20 Ra (SFF1)		15 Ra-EP (SFF4)		10 Ra MAX-EP		Unpolished #0 (PU)	A in	B in
	#3 (PC)	#7 (PL)	#3E (PD)	#7E (PM)	#3E (PJ)	#7E (PR)			
1/2	070L0AE061	070L0BE061	070L0AE071	070L0BE071	070L0GE071	070L0HE071	070L00E061	2-1/4	4-1/2
3/4	070L0AF061	070L0BF061	070L0AF071	070L0BF071	070L0GF071	070L0HF071	070L00F061	2-3/8	4-3/4
1	070L0A1061	070L0B1061	070L0A1071	070L0B1071	070L0G1071	070L0H1071	070L001061	2-5/8	5-1/4
1-1/2	070L0A2061	070L0B2061	070L0A2071	070L0B2071	070L0G2071	070L0H2071	070L002061	2-7/8	5-3/4
2	070L0A3061	070L0B3061	070L0A3071	070L0B3071	070L0G3071	070L0H3071	070L003061	3-3/8	6-3/4
2-1/2	070L0A4061	070L0B4061	070L0A4071	070L0B4071	070L0G4071	070L0H4071	070L004061	3-5/8	7-1/4
3	070L0A5061	070L0B5061	070L0A5071	070L0B5071	070L0G5071	070L0H5071	070L005061	3-7/8	7-3/4
4	070L0A6061	070L0B6061	070L0A6071	070L0B6071	070L0G6071	070L0H6071	070L006061	4-3/4	9-1/2
6	070L0A7061	070L0B7061	070L0A7071	070L0B7071	070L0G7071	070L0H7071	070L007061	7-1/8	14-1/4

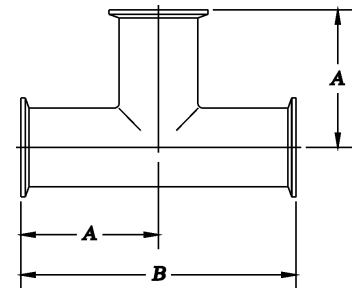

S7MP

## CROSS T316L BPE

SIZE (in)	20 Ra (SFF1)		15 Ra-EP (SFF4)		10 Ra MAX-EP		Unpolished #0 (PU)	A in	B in
	#3 (PC)	#7 (PL)	#3E (PD)	#7E (PM)	#3E (PJ)	#7E (PR)			
1/2	090L0AE061	090L0BE061	090L0AE071	090L0BE071	090L0GE071	090L0HE071	090L00E061	2-1/4	4-1/2
3/4	090L0AF061	090L0BF061	090L0AF071	090L0BF071	090L0GF071	090L0HF071	090L00F061	2-3/8	4-3/4
1	090L0A1061	090L0B1061	090L0A1071	090L0B1071	090L0G1071	090L0H1071	090L001061	2-5/8	5-1/4
1-1/2	090L0A2061	090L0B2061	090L0A2071	090L0B2071	090L0G2071	090L0H2071	090L002061	2-7/8	5-3/4
2	090L0A3061	090L0B3061	090L0A3071	090L0B3071	090L0G3071	090L0H3071	090L003061	3-3/8	6-3/4
2-1/2	090L0A4061	090L0B4061	090L0A4071	090L0B4071	090L0G4071	090L0H4071	090L004061	3-5/8	7-1/4
3	090L0A5061	090L0B5061	090L0A5071	090L0B5071	090L0G5071	090L0H5071	090L005061	3-7/8	7-3/4
4	090L0A6061	090L0B6061	090L0A6071	090L0B6071	090L0G6071	090L0H6071	090L006061	4-3/4	9-1/2
6	090L0A7061	090L0B7061	090L0A7071	090L0B7071	090L0G7071	090L0H7071	090L007061	7-1/8	14-1/4

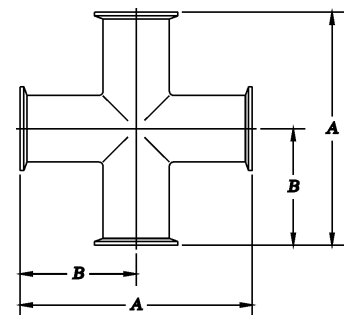

S9MP

**REDUCING TEE T316L BPE**

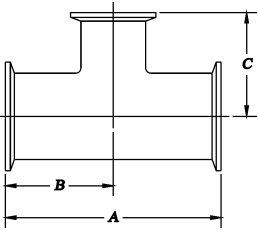

**S7RMP**

SIZE (in)	20 Ra (SFF1)		15 Ra-EP (SFF4)		10 Ra MAX-EP		Unpolished #0 (PU)	A in	B in	C in
	#3 (PC)	#7 (PL)	#3E (PD)	#7E (PM)	#3E (PJ)	#7E (PR)				
3/4 x 1/2	075L0AFE61	075L0BFE61	075L0AFE71	075L0BFE71	075L0GFE71	075L0HFE71	075L00FE61	5	2-1/2	2-1/2
1 x 1/2	075L0A1E61	075L0B1E61	075L0A1E71	075L0B1E71	075L0G1E71	075L0H1E71	075L001E61	5-1/4	2-5/8	2-5/8
1 x 3/4	075L0A1F61	075L0B1F61	075L0A1F71	075L0B1F71	075L0G1F71	075L0H1F71	075L001F61	5-1/4	2-5/8	2-5/8
1-1/2 x 1/2	075L0A2E61	075L0B2E61	075L0A2E71	075L0B2E71	075L0G2E71	075L0H2E71	075L002E61	5-3/4	2-7/8	2-7/8
1-1/2 x 3/4	075L0A2F61	075L0B2F61	075L0A2F71	075L0B2F71	075L0G2F71	075L0H2F71	075L002F61	5-3/4	2-7/8	2-7/8
1-1/2 x 1	075L0A2161	075L0B2161	075L0A2171	075L0B2171	075L0G2171	075L0H2171	075L002161	5-3/4	2-7/8	2-7/8
2 x 1/2	075L0A3E61	075L0B3E61	075L0A3E71	075L0B3E71	075L0G3E71	075L0H3E71	075L003E61	6-3/4	3-3/8	3-1/8
2 x 3/4	075L0A3F61	075L0B3F61	075L0A3F71	075L0B3F71	075L0G3F71	075L0H3F71	075L003F61	6-3/4	3-3/8	3-1/8
2 x 1	075L0A3161	075L0B3161	075L0A3171	075L0B3171	075L0G3171	075L0H3171	075L003161	6-3/4	3-3/8	3-1/8
2 x 1-1/2	075L0A3261	075L0B3261	075L0A3271	075L0B3271	075L0G3271	075L0H3271	075L003261	6-3/4	3-3/8	3-1/8
2-1/2 x 1/2	075L0A4E61	075L0B4E61	075L0A4E71	075L0B4E71	075L0G4E71	075L0H4E71	075L004E61	7-1/4	3-5/8	3-3/8
2-1/2 x 3/4	075L0A4F61	075L0B4F61	075L0A4F71	075L0B4F71	075L0G4F71	075L0H4F71	075L004F61	7-1/4	3-5/8	3-3/8
2-1/2 x 1	075L0A4161	075L0B4161	075L0A4171	075L0B4171	075L0G4171	075L0H4171	075L004161	7-1/4	3-5/8	3-3/8
2-1/2 x 1-1/2	075L0A4261	075L0B4261	075L0A4271	075L0B4271	075L0G4271	075L0H4271	075L004261	7-1/4	3-5/8	3-3/8
2-1/2 x 2	075L0A4361	075L0B4361	075L0A4371	075L0B4371	075L0G4371	075L0H4371	075L004361	7-1/4	3-5/8	3-3/8
3 x 1/2	075L0A5E61	075L0B5E61	075L0A5E71	075L0B5E71	075L0G5E71	075L0H5E71	075L005E61	7-3/4	3-7/8	3-5/8
3 x 3/4	075L0A5F61	075L0B5F61	075L0A5F71	075L0B5F71	075L0G5F71	075L0H5F71	075L005F61	7-3/4	3-7/8	3-5/8
3 x 1	075L0A5161	075L0B5161	075L0A5171	075L0B5171	075L0G5171	075L0H5171	075L005161	7-3/4	3-7/8	3-5/8
3 x 1-1/2	075L0A5261	075L0B5261	075L0A5271	075L0B5271	075L0G5271	075L0H5271	075L005261	7-3/4	3-7/8	3-5/8
3 x 2	075L0A5361	075L0B5361	075L0A5371	075L0B5371	075L0G5371	075L0H5371	075L005361	7-3/4	3-7/8	3-5/8
3 x 2-1/2	075L0A5461	075L0B5461	075L0A5471	075L0B5471	075L0G5471	075L0H5471	075L005461	7-3/4	3-7/8	3-5/8
4 x 1/2	075L0A6E61	075L0B6E61	075L0A6E71	075L0B6E71	075L0G6E71	075L0H6E71	075L006E61	9-1/2	4-3/4	4-1/8
4 x 3/4	075L0A6F61	075L0B6F61	075L0A6F71	075L0B6F71	075L0G6F71	075L0H6F71	075L006F61	9-1/2	4-3/4	4-1/8
4 x 1	075L0A6161	075L0B6161	075L0A6171	075L0B6171	075L0G6171	075L0H6171	075L006161	9-1/2	4-3/4	4-1/8
4 x 1-1/2	075L0A6261	075L0B6261	075L0A6271	075L0B6271	075L0G6271	075L0H6271	075L006261	9-1/2	4-3/4	4-1/8
4 x 2	075L0A6361	075L0B6361	075L0A6371	075L0B6371	075L0G6371	075L0H6371	075L006361	9-1/2	4-3/4	4-3/8
4 x 2-1/2	075L0A6461	075L0B6461	075L0A6471	075L0B6471	075L0G6471	075L0H6471	075L006461	9-1/2	4-3/4	4-3/8
4 x 3	075L0A6561	075L0B6561	075L0A6571	075L0B6571	075L0G6571	075L0H6571	075L006561	9-1/2	4-3/4	4-3/8
6 x 4*	075L0A7661	075L0B7661	075L0A7671	075L0B7671	075L0G7671	075L0H7671	075L007661	14-1/4	7-1/8	5-3/4

\*Other sizes available

## SHORT OUTLET REDUCING TEE T316L BPE

SIZE (in)	20 Ra (SFF1)		15 Ra-EP (SFF4)		10 Ra MAX-EP		Unpolished #0 (PU)	A in	B in	C in
	#3 (PC)	#7 (PL)	#3E (PD)	#7E (PM)	#3E (PJ)	#7E (PR)				
3/4 x 1/2	071L0AFE61	071L0BFE61	071L0AFE71	071L0BFE71	071L0GFE71	071L0HFE71	071L00FE61	5	2-1/2	1
1 x 1/2	071L0A1E61	071L0B1E61	071L0A1E71	071L0B1E71	071L0G1E71	071L0H1E71	071L001E61	5-1/4	2-5/8	1-1/8
1 x 3/4	071L0A1F61	071L0B1F61	071L0A1F71	071L0B1F71	071L0G1F71	071L0H1F71	071L001F61	5-1/4	2-5/8	1-1/8
1-1/2 x 1/2	071L0A2E61	071L0B2E61	071L0A2E71	071L0B2E71	071L0G2E71	071L0H2E71	071L002E61	5-3/4	2-7/8	1-3/8
1-1/2 x 3/4	071L0A2F61	071L0B2F61	071L0A2F71	071L0B2F71	071L0G2F71	071L0H2F71	071L002F61	5-3/4	2-7/8	1-3/8
1-1/2 x 1	071L0A2161	071L0B2161	071L0A2171	071L0B2171	071L0G2171	071L0H2171	071L002161	5-3/4	2-7/8	1-3/8
2 x 1/2	071L0A3E61	071L0B3E61	071L0A3E71	071L0B3E71	071L0G3E71	071L0H3E71	071L003E61	6-3/4	3-3/8	1-5/8
2 x 3/4	071L0A3F61	071L0B3F61	071L0A3F71	071L0B3F71	071L0G3F71	071L0H3F71	071L003F61	6-3/4	3-3/8	1-5/8
2 x 1	071L0A3161	071L0B3161	071L0A3171	071L0B3171	071L0G3171	071L0H3171	071L003161	6-3/4	3-3/8	1-5/8
2 x 1-1/2	071L0A3261	071L0B3261	071L0A3271	071L0B3271	071L0G3271	071L0H3271	071L003261	6-3/4	3-3/8	1-5/8
2-1/2 x 1/2	071L0A4E61	071L0B4E61	071L0A4E71	071L0B4E71	071L0G4E71	071L0H4E71	071L004E61	7-1/4	3-5/8	1-7/8
2-1/2 x 3/4	071L0A4F61	071L0B4F61	071L0A4F71	071L0B4F71	071L0G4F71	071L0H4F71	071L004F61	7-1/4	3-5/8	1-7/8
2-1/2 x 1	071L0A4161	071L0B4161	071L0A4171	071L0B4171	071L0G4171	071L0H4171	071L004161	7-1/4	3-5/8	1-7/8
2-1/2 x 1-1/2	071L0A4261	071L0B4261	071L0A4271	071L0B4271	071L0G4271	071L0H4271	071L004261	7-1/4	3-5/8	1-7/8
2-1/2 x 2	071L0A4361	071L0B4361	071L0A4371	071L0B4371	071L0G4371	071L0H4371	071L004361	7-1/4	3-5/8	1-7/8
3 x 1/2	071L0A5E61	071L0B5E61	071L0A5E71	071L0B5E71	071L0G5E71	071L0H5E71	071L005E61	7-3/4	3-7/8	2-1/8
3 x 3/4	071L0A5F61	071L0B5F61	071L0A5F71	071L0B5F71	071L0G5F71	071L0H5F71	071L005F61	7-3/4	3-7/8	2-1/8
3 x 1	071L0A5161	071L0B5161	071L0A5171	071L0B5171	071L0G5171	071L0H5171	071L005161	7-3/4	3-7/8	2-1/8
3 x 1-1/2	071L0A5261	071L0B5261	071L0A5271	071L0B5271	071L0G5271	071L0H5271	071L005261	7-3/4	3-7/8	2-1/8
3 x 2	071L0A5361	071L0B5361	071L0A5371	071L0B5371	071L0G5371	071L0H5371	071L005361	7-3/4	3-7/8	2 1/8
3 x 2-1/2	071L0A5461	071L0B5461	071L0A5471	071L0B5471	071L0G5471	071L0H5471	071L005461	7-3/4	3-7/8	2-1/8
4 x 1/2	071L0A6E61	071L0B6E61	071L0A6E71	071L0B6E71	071L0G6E71	071L0H6E71	071L006E61	9-1/2	4-3/4	2-5/8
4 x 3/4	071L0A6F61	071L0B6F61	071L0A6F71	071L0B6F71	071L0G6F71	071L0H6F71	071L006F61	9-1/2	4-3/4	2-5/8
4 x 1	071L0A6161	071L0B6161	071L0A6171	071L0B6171	071L0G6171	071L0H6171	071L006161	9-1/2	4-3/4	2-5/8
4 x 1-1/2	071L0A6261	071L0B6261	071L0A6271	071L0B6271	071L0G6271	071L0H6271	071L006261	9-1/2	4-3/4	2-5/8
4 x 2	071L0A6361	071L0B6361	071L0A6371	071L0B6371	071L0G6371	071L0H6371	071L006361	9-1/2	4-3/4	2-5/8
4 x 2-1/2	071L0A6461	071L0B6461	071L0A6471	071L0B6471	071L0G6471	071L0H6471	071L006461	9-1/2	4-3/4	2-5/8
4 x 3	071L0A6561	071L0B6561	071L0A6571	071L0B6571	071L0G6571	071L0H6571	071L006561	9-1/2	4-3/4	2-5/8
6 x 4*	071L0A7661	071L0B7661	071L0A7671	071L0B7671	071L0G7671	071L0H7671	071L007661	14-1/4	7-1/8	3-3/4

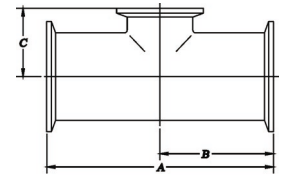

S7RMPS

\*Other sizes available

**INSTRUMENT TEE WITH CLAMP ENDS T316L BPE**

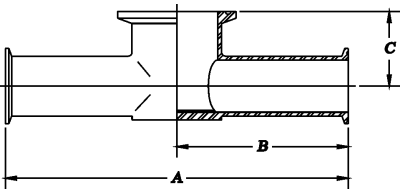

**S7RSGTMP**

SIZE (in)	20 Ra (SFF1)		15 Ra-EP (SFF4)		10 Ra MAX EP		A	B	C
	#7 (PL)	#7E (PM)	#7E (PR)				in	in	in
1/2 x 1-1/2	076LOBE261	076LOBE271	076LOHE271				6	3	7/8
3/4 x 1-1/2	076LOBF261	076LOBF271	076LOHF271				6	3	1
1 x 1-1/2	076LOB1261	076LOB1271	076LOH1271				6	3	1-1/8
1/2 x 2	076LOBE361	076LOBE371	076LOHE371				6-1/2	3-1/4	1
3/4 x 2	076LOBF361	076LOBF371	076LOHF371				6-1/2	3-1/4	1-1/8
1 x 2	076LOB1361	076LOB1371	076LOH1371				6-1/2	3-1/4	1-1/4
1-1/2 x 2	076LOB2361	076LOB2371	076LOH2371				6-1/2	3-1/4	1-1/2

**SHORT OUTLET TEE T316L BPE**

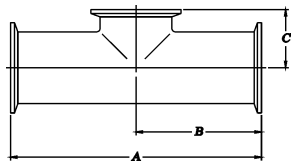

**S7MPS**

SIZE (in)	20 Ra (SFF1)		15 Ra-EP (SFF4)		10 Ra MAX-EP		Unpolished	A	B	C
	#3 (PC)	#7 (PL)	#3E (PD)	#7E (PM)	#3E (PJ)	#7E (PR)	#0 (PU)	in	in	in
1/2	071LOAE061	071LOBE061	071LOAE071	071LOBE071	071LOGE071	071LOHE071	071L00E061	4-1/2	2-14	1
3/4	071LOAF061	071LOBF061	071LOAF071	071LOBF071	071LOGF071	071LOHF071	071L00F061	4-3/4	2-3/8	1-1/8
1	071LOA1061	071LOB1061	071LOA1071	071LOB1071	071LOG1071	071LOH1071	071L001061	5-1/4	2-5/8	1-1/8
1-1/2	071LOA2061	071LOB2061	071LOA2071	071LOB2071	071LOG2071	071LOH2071	071L002061	5-3/4	2-7/8	1-3/8
2	071LOA3061	071LOB3061	071LOA3071	071LOB3071	071LOG3071	071LOH3071	071L003061	6-3/4	3-3/8	1-5/8
2-1/2	071LOA4061	071LOB4061	071LOA4071	071LOB4071	071LOG4071	071LOH4071	071L004061	7-1/2	3-5/8	1-7/8
3	071LOA5061	071LOB5061	071LOA5071	071LOB5071	071LOG5071	071LOH5071	071L005061	7-3/4	3-7/8	2-1/8
4	071LOA6061	071LOB6061	071LOA6071	071LOB6071	071LOG6071	071LOH6071	071L006061	9-1/2	4-3/4	2-3/4
6	071LOA7061	071LOB7061	071LOA7071	071LOB7071	071LOG7071	071LOH7071	071L007061	14-1/4	7-1/8	4-5/8

## CONCENTRIC REDUCER T316L BPE

SIZE (in)	20 Ra (SFF1)		15 Ra-EP (SFF4)		10 Ra MAX-EP		Unpolished #0 (PU)	A in
	#3 (PC)	#7 (PL)	#3E (PD)	#7E (PM)	#3E (PJ)	#7E (PR)		
3/4 x 1/2	310L0AFE61	310L0BFE61	310L0AFE71	310L0BFE71	310LOGFE71	310LOHFE71	310L00FE61	2
1 x 1/2	310L0A1E61	310L0B1E61	310L0A1E71	310L0B1E71	310LOG1E71	310LOH1E71	310L001E61	2-1/2
1 x 3/4	310L0A1F61	310L0B1F61	310L0A1F71	310L0B1F71	310LOG1F71	310LOH1F71	310L001F61	2
1-1/2 x 1/2	310L0A2E61	310L0B2E61	310L0A2E71	310L0B2E71	310LOG2E71	310LOH2E71	310L002E61	3-1/2
1-1/2 x 3/4	310L0A2F61	310L0B2F61	310L0A2F71	310L0B2F71	310LOG2F71	310LOH2F71	310L002F61	3
1-1/2 x 1	310L0A2161	310L0B2161	310L0A2171	310L0B2171	310LOG2171	310LOH2171	310L002161	3
2 x 1/2	310L0A3E61	310L0B3E61	310L0A3E71	310L0B3E71	310LOG3E71	310LOH3E71	310L003E61	5-1/2
2 x 3/4	310L0A3F61	310L0B3F61	310L0A3F71	310L0B3F71	310LOG3F71	310LOH3F71	310L003F61	5
2 x 1	310L0A3161	310L0B3161	310L0A3171	310L0B3171	310LOG3171	310LOH3171	310L003161	5
2 x 1-1/2	310L0A3261	310L0B3261	310L0A3271	310L0B3271	310LOG3271	310LOH3271	310L003261	3
2-1/2 x 1/2	310L0A4E61	310L0B4E61	310L0A4E71	310L0B4E71	310LOG4E71	310LOH4E71	310L004E61	7-1/2
2-1/2 x 3/4	310L0A4F61	310L0B4F61	310L0A4F71	310L0B4F71	310LOG4F71	310LOH4F71	310L004F61	7
2-1/2 x 1	310L0A4161	310L0B4161	310L0A4171	310L0B4171	310LOG4171	310LOH4171	310L004161	7
2-1/2 x 1-1/2	310L0A4261	310L0B4261	310L0A4271	310L0B4271	310LOG4271	310LOH4271	310L004261	5
2-1/2 x 2	310L0A4361	310L0B4361	310L0A4371	310L0B4371	310LOG4371	310LOH4371	310L004361	3
3 x 1	310L0A5161	310L0B5161	310L0A5171	310L0B5171	310LOG5171	310LOH5171	310L005161	9
3 x 1-1/2	310L0A5261	310L0B5261	310L0A5271	310L0B5271	310LOG5271	310LOH5271	310L005261	7
3 x 2	310L0A5361	310L0B5361	310L0A5371	310L0B5371	310LOG5371	310LOH5371	310L005361	5
3 x 2-1/2	310L0A5461	310L0B5461	310L0A5471	310L0B5471	310LOG5471	310LOH5471	310L005461	3
4 x 1	310L0A6161	310L0B6161	310L0A6171	310L0B6171	310LOG6171	310LOH6171	310L006161	13-1/8
4 x 1-1/2	310L0A6261	310L0B6261	310L0A6271	310L0B6271	310LOG6271	310LOH6271	310L006261	11-1/8
4 x 2	310L0A6361	310L0B6361	310L0A6371	310L0B6371	310LOG6371	310LOH6371	310L006361	9-1/8
4 x 2-1/2	310L0A6461	310L0B6461	310L0A6471	310L0B6471	310LOG6471	310LOH6471	310L006461	7-1/8
4 x 3	310L0A6561	310L0B6561	310L0A6571	310L0B6571	310LOG6571	310LOH6571	310L006561	5-1/8
6 x 4*	310L0A7661	310L0B7661	310L0A7671	310L0B7671	310LOG7671	310LOH7671	310L007661	7-5/8

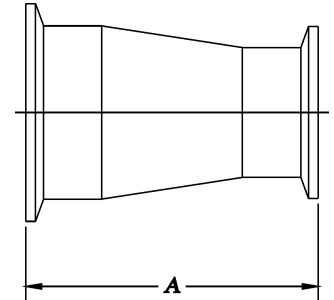

**S31-14MP**

\*Other sizes available

**ECCENTRIC REDUCER T316L BPE**

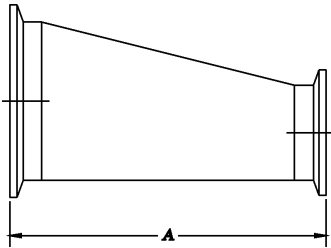

**S32-14MP**

SIZE (in)	20 Ra (SFF1)		15 Ra-EP (SFF4)		10 Ra MAX-EP (SFF4)		Unpolished	A
	#3 (PC)	#7 (PL)	#3E (PD)	#7E (PM)	#3E (PJ)	#7E (PR)	#0 (PU)	in
3/4 x 1/2	320L0AFE61	320L0BFE61	320L0AFE71	320L0BFE71	320L0GFE71	320L0HFE71	320L00FE61	2
1 x 1/2	320L0A1E61	320L0B1E61	320L0A1E71	320L0B1E71	320L0G1E71	320L0H1E71	320L001E61	2-1/2
1 x 3/4	320L0A1F61	320L0B1F61	320L0A1F71	320L0B1F71	320L0G1F71	320L0H1F71	320L001F61	2
1-1/2 x 1/2	320L0A2E61	320L0B2E61	320L0A2E71	320L0B2E71	320L0G2E71	320L0H2E71	320L002E61	3-1/2
1-1/2 x 3/4	320L0A2F61	320L0B2F61	320L0A2F71	320L0B2F71	320L0G2F71	320L0H2F71	320L002F61	3
1-1/2 x 1	320L0A2161	320L0B2161	320L0A2171	320L0B2171	320L0G2171	320L0H2171	320L002161	3
2 x 1/2	320L0A3E61	320L0B3E61	320L0A3E71	320L0B3E71	320L0G3E71	320L0H3E71	320L003E61	5-1/2
2 x 3/4	320L0A3F61	320L0B3F61	320L0A3F71	320L0B3F71	320L0G3F71	320L0H3F71	320L003F61	5
2 x 1	320L0A3161	320L0B3161	320L0A3171	320L0B3171	320L0G3171	320L0H3171	320L003161	5
2 x 1-1/2	320L0A3261	320L0B3261	320L0A3271	320L0B3271	320L0G3271	320L0H3271	320L003261	3
2-1/2 x 1/2	320L0A4E61	320L0B4E61	320L0A4E71	320L0B4E71	320L0G4E71	320L0H4E71	320L004E61	7-1/2
2-1/2 x 3/4	320L0A4F61	320L0B4F61	320L0A4F71	320L0B4F71	320L0G4F71	320L0H4F71	320L004F61	7
2-1/2 x 1	320L0A4161	320L0B4161	320L0A4171	320L0B4171	320L0G4171	320L0H4171	320L004161	7
2-1/2 x 1-1/2	320L0A4261	320L0B4261	320L0A4271	320L0B4271	320L0G4271	320L0H4271	320L004261	5
2-1/2 x 2	320L0A4361	320L0B4361	320L0A4371	320L0B4371	320L0G4371	320L0H4371	320L004361	3
3 x 1	320L0A5161	320L0B5161	320L0A5171	320L0B5171	320L0G5171	320L0H5171	320L005161	9
3 x 1-1/2	320L0A5261	320L0B5261	320L0A5271	320L0B5271	320L0G5271	320L0H5271	320L005261	7
3 x 2	320L0A5361	320L0B5361	320L0A5371	320L0B5371	320L0G5371	320L0H5371	320L005361	5
3 x 2-1/2	320L0A5461	320L0B5461	320L0A5471	320L0B5471	320L0G5471	320L0H5471	320L005461	3
4 x 1	320L0A6161	320L0B6161	320L0A6171	320L0B6171	320L0G6171	320L0H6171	320L006161	13-1/8
4 x 1-1/2	320L0A6261	320L0B6261	320L0A6271	320L0B6271	320L0G6271	320L0H6271	320L006261	11-1/8
4 x 2	320L0A6361	320L0B6361	320L0A6371	320L0B6371	320L0G6371	320L0H6371	320L006361	9-1/8
4 x 2-1/2	320L0A6461	320L0B6461	320L0A6471	320L0B6471	320L0G6471	320L0H6471	320L006461	7-1/8
4 x 3	320L0A6561	320L0B6561	320L0A6571	320L0B6571	320L0G6571	320L0H6571	320L006561	5-1/8
6 x 4*	320L0A7661	320L0B7661	320L0A7671	320L0B7671	320L0G7671	320L0H7671	320L007661	7-5/8

\*Other sizes available

## WELDING FERRULE T316L

SIZE (in)	20 Ra (SFF1)	15 Ra-EP (SFF4)	10 Ra-MAX EP	A
	#7 (PL)	#7E (PM)	#7E (PR)	in
1/2	140LOBE061	140LOBE071	140LOHE071	1/2
3/4	140LOBF061	140LOBF071	140LOHF071	1/2
1	140LOB1061	140LOB1071	140LOH1071	1/2
1-1/2	140LOB2061	140LOB2071	140LOH2071	1/2
2	140LOB3061	140LOB3071	140LOH3071	1/2
2-1/2	140LOB4061	140LOB4071	140LOH4071	1/2
3	140LOB5061	140LOB5071	140LOH5071	1/2
4	140LOB6061	140LOB6071	140LOH6071	5/8
6	140LOB7061	140LOB7071	140LOH7071	7/8

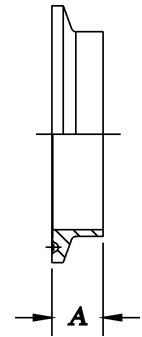

S14WMP

## STUB END T316L

SIZE (in)	20 Ra (SFF1)		15 Ra-EP (SFF4)		10 Ra MAX-EP		Unpolished	A
	#3 FINISH	#7 (PL)	#3E (PD)	#7E (PM)	#3E (PJ)	#7E (PR)	#0 (PU)	in
1/2	14890AE061	14890BE061	14890AE071	14890BE071	14890GE071	14890HE071	148900E061	2-3/4
3/4	14890AF061	14890BF061	14890AF071	14890BF071	14890GF071	14890HF071	148900F061	2-3/4
1	14890A1061	14890B1061	14890A1071	14890B1071	14890G1071	14890H1071	1489001061	2-3/4
1-1/2	14890A2061	14890B2061	14890A2071	14890B2071	14890G2071	14890H2071	1489002061	2-3/4
2	14890A3061	14890B3061	14890A3071	14890B3071	14890G3071	14890H3071	1489003061	2-3/4
2-1/2	14890A4061	14890B4061	14890A4071	14890B4071	14890G4071	14890H4071	1489004061	2-3/4
3	14890A5061	14890B5061	14890A5071	14890B5071	14890G5071	14890H5071	1489005061	2-3/4
4	14890A6061	14890B6061	14890A6071	14890B6071	14890G6071	14890H6071	1489006061	2-3/4
6	14890A7061	14890B7061	14890A7071	14890B7071	14890G7071	14890H7071	1489007061	2-3/4

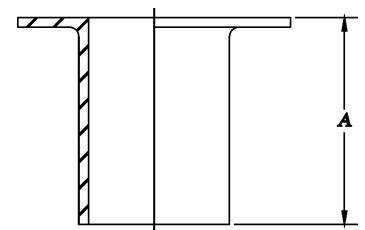

S14WA

## CAP T316L

SIZE (in)	20 Ra (SFF1)	15 Ra-EP (SFF4)	10 Ra-MAX EP	A
	#7 (PL)	#7E (PM)	#7E (PR)	in
1/2	160LOBE061	160LOBE071	160LOHE071	1
3/4	160LOBF061	160LOBF071	160LOHF071	1
1	160LOB1061	160LOB1071	160LOH1071	2
1-1/2	160LOB2061	160LOB2071	160LOH2071	2
2	160LOB3061	160LOB3071	160LOH3071	1-17/32
2-1/2	160LOB4061	160LOB4071	160LOH4071	3-1/16
3	160LOB5061	160LOB5071	160LOH5071	3-9/16
4	160LOB6061	160LOB6071	160LOH6071	4-11/16
6	160LOB7061	160LOB7071	160LOH7071	6-9/16

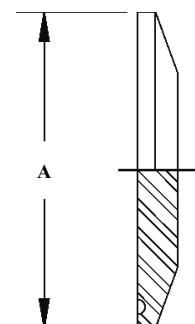

S16AMP

## CLAMPS & GASKETS\*

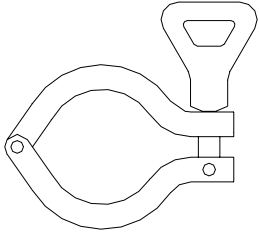

**13MHHM**  
(Highly Polished)

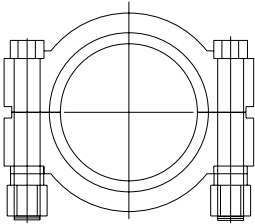

**13MHP**

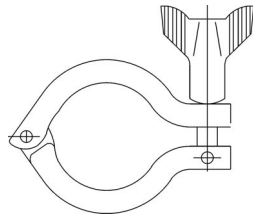

**P13MHHM**

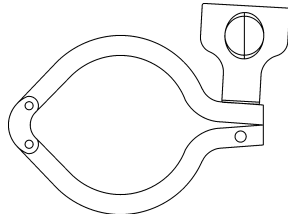

**PW13MHHM**

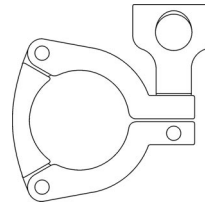

**P13MHHS**

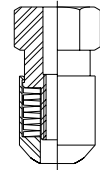

**13MHHMLL**

SIZE (in)	13MHHM HEAVY DUTY CLAMP	13MHP HIGH PRESSURE CLAMP	P13MHHM HEAVY DUTY CLAMP	PW13MHHM TWO PIECE CLAMP	P13MHHS THREE PIECE CLAMP	13MHHMLL LIVE LOADING NUT ASSEMBLY
1/2 and 3/4	119-109	-	P119-109	-	-	THREAD SIZE
1 and 1-1/2	119-28	119-270	P119-28	P119-284	P119-289	5/16-18
2	119-30	119-271	P119-30	P119-285	P119-290	136-127
2-1/2	119-33	119-272	P119-33	P119-286	P119-291	
3	119-34	119-273	P119-34	P119-287	P119-292	
4	119-49	119-274	P119-49	P119-288	P119-293	
6	119-71	-	P119-71	-	-	
8	119-70	-	-	-	-	
10	119-69	-	-	-	-	

\* WCB-Flow Products offers a variety of gaskets and Class VI elastomers.

## WCB-Flow Products

An SPX Process Equipment Operation

699 Hertel Ave. Suite 260, Buffalo, NY 14207 U.S.A.  
TEL: 1.800.777.1325 or 716.871.0001 FAX: 1.716.871.0923

E-mail: [info@processequipment.spx.com](mailto:info@processequipment.spx.com)

Web: [www.spxprocessequipment.com](http://www.spxprocessequipment.com)